



REVERIE

LIGHTER | FASTER | STRONGER

PARTS BROCHURE

LOTUS

REVERIE

LIGHTER | FASTER | STRONGER

ABOUT US

Established in 2000 in Colchester, Essex, UK by former Lotus engineer Simon Farren, Reverie started by designing and producing niche track day and aftermarket Carbon Fibre performance parts, primarily for Lotus models. Growing quickly, in 2001 Reverie started offering composite engineering and manufacturing services to small car manufacturers, motorsport manufacturing companies and race teams. Caterham Cars commissioned Reverie to design, manufacture and supply a complete induction silencer system for their R500 with K-Series engine. Between 2003 and 2005, Reverie was proudly involved in winning a large motorsport composite project for Foggy PETRONAS Racing, involving the manufacture of 150 full panel sets for the FP1 homologation special motorbike. All delivery times and quality targets were met for both the OEM manufacturing company and the FP1 race team. After gaining ISO9001 certification in 2014, Reverie was selected to manufacture Carbon Fibre OEM key fobs for McLaren (MP4/12 P1) to very high clear coated paint specifications. This large contract involved manufacturing over 24,000 units.



MD, Simon J. Farren

WHY CHOOSE REVERIE?

An established world-wide market leader with passionate, professional and highly skilled staff who offer composites design, manufacturing and repair skills. A technical sales team with real practical knowledge of road/race and track applications and fitments of our Product ranges be it aerodynamics or powertrain enhancing to help you select the best solution and support you to fit our products. We have a one-stop shop - Composite cutting, laminating, curing, CNC machining, painting, polishing and inspection. We proudly supply LMP1/WRC Motorsport teams and manufacturers, not F1 including for example Cosworth Electronics, Gibson Technology, Lazer lamps, M-Sport. Because we do not supply F1 means we are not seasonal and will therefore not increase or inflate our prices or hold up your Reverie parts order. With full ISO 9001 quality status, as a customer you can be assured of the very best customer service, continuing service and product improvements and highest quality products and services, we need, like, internally monitor / report and respect your valued feedback.

[View terms and conditions.](#)

WHY THE AUTOCLAVED PROCESS?

We predominantly use pre-impregnated epoxy thermoset composite materials to ensure that high fibre contents can be achieved consistently. We also CNC cut, then meticulously hand lay, vacuum bag and autoclave all the layers to further ensure low void contents and trapped volatiles to maximise interlaminar shear properties by forcing the various layers in the fibre/resin matrix together. This process as used widely in F1 results in high quality lightweight, cosmetic grade parts achievable time and time again, with low void content and surface pin-holing.





CONTENTS

Lotus 2-Eleven	4
Lotus 340R	8
Lotus Elise S1 (96 - 01)	12
Lotus Elise S2 (01 - 11)	16
Lotus Elise S3 (11 -)	22
Lotus Evora	23
Lotus Exige S1 (00 - 02)	24
Lotus Exige S2 (04 - 11)	27
Lotus Exige S3 V6 (12 -)	32
Lotus Bucket Seats	34
Lotus Bucket Seat Cushion Kits	40
Lotus Gear Shift Knobs & Steering Wheels	44



LOTUS 2-ELEVEN

We manufacture a range of products for the Lotus 2-Eleven manufactured between 2007 - 2011. The 2-Eleven is powered by the Toyota 2ZZ-GE engine for which we manufacture induction kits and engine covers. We also manufacture interior parts, seats, steering wheels, rear wings, front spoilers, mid-floor sections and diffusers for the 2-Eleven.



Direct OEM replacement using original fixings



Can be supplied without NACA ducts (advise when ordering) Increased width floor section for use with diffuser **12**



for seats, see [page 34](#)

Part No.	ENGINE/INDUCTION KITS 2ZZ-GE ENGINE	£ (Ex. VAT)
1 R01SE0276	Non-Ducted Alloy Air Induction Kit (D230A)	£303.45
2 R01SE0277	Non-Ducted Air Induction Kit (D230C)	£366.45
R01SE0278	Non-Ducted Air Induction Kit (D230CX)	£418.95
3 R01SE0284	Spark Plug Cover	£189.00
4 R01SE0441	Engine Cover	£189.00
EXTERIOR		
5 R01SB6053	Fibre Front Splitter	£549.00
6 R01SB0180	Rear Floor Section	£799.00
R01SB0325	Rear Floor Section Alloy Honeycomb	£799.00
7 R01SB0248	Rear Floor Section (Wide)	£799.00
R01SB0324	Rear Floor Section (Wide) Alloy Honeycomb	£799.00
8 R01SB0040	Rear Diffuser Single Element	£469.00
9 R01SB0109	Rear Diffuser 3 Element	£699.00
10 R01SB0110	Rear Diffuser 5 Element	£799.00
11 R01SB0253	Rear Diffuser 3 Element, Wide Mid-Floor Only	£870.45
R01SB0251	Rear Diffuser 3 Element, 3 Fixing Holes Wide Mid-Floor Only	£870.45
R01SB0252	Rear Diffuser 3 Element, 5 Fixing Holes Wide Mid-Floor Only	£870.45
12 R01SB0548	Rear Wing Kit 310mm Chord Low Drag	£1363.95
13 R01SB0246	Rear Wing Kit (Straight) 225mm Chord x W1650mm, Adjustable	£996.45
INTERIOR		
14 R01SU0223	Centre Tunnel LHD	£314.95
15 R01SU0220	Centre Tunnel RHD (see page 7)	£314.95



Wing tabs allow for AoA adjustment to finely balance the wing's down force

10



11



Note; diffuser shown on an Exige

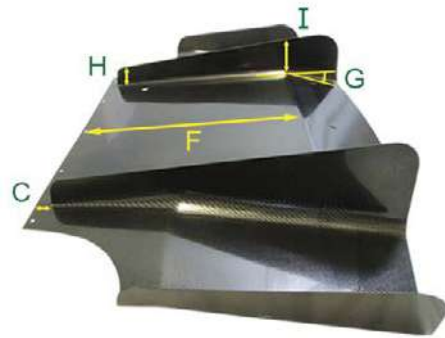
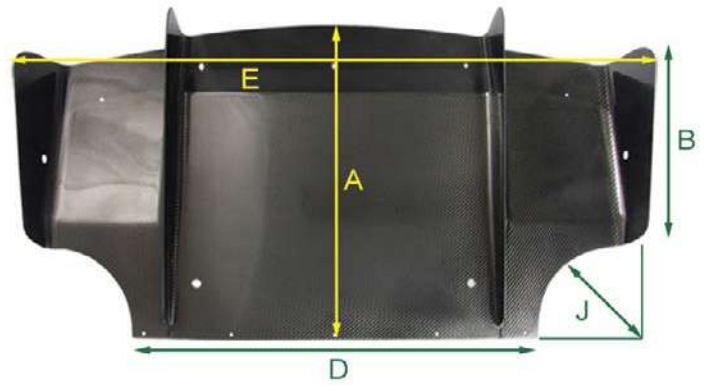

PART #	A	B	C	D	E	F	G	H	I	J
R01SB0040	690	395	30	790	1195	445	16	90	120	180
R01SB0109	690	395	30	790	1195	445	16	90	120	180
R01SB0110	690	395	30	790	1195	445	16	90	120	180
R01SB0251/2/3	740	650	35	1180	1180	N/A	N/A	45	120	N/A



10

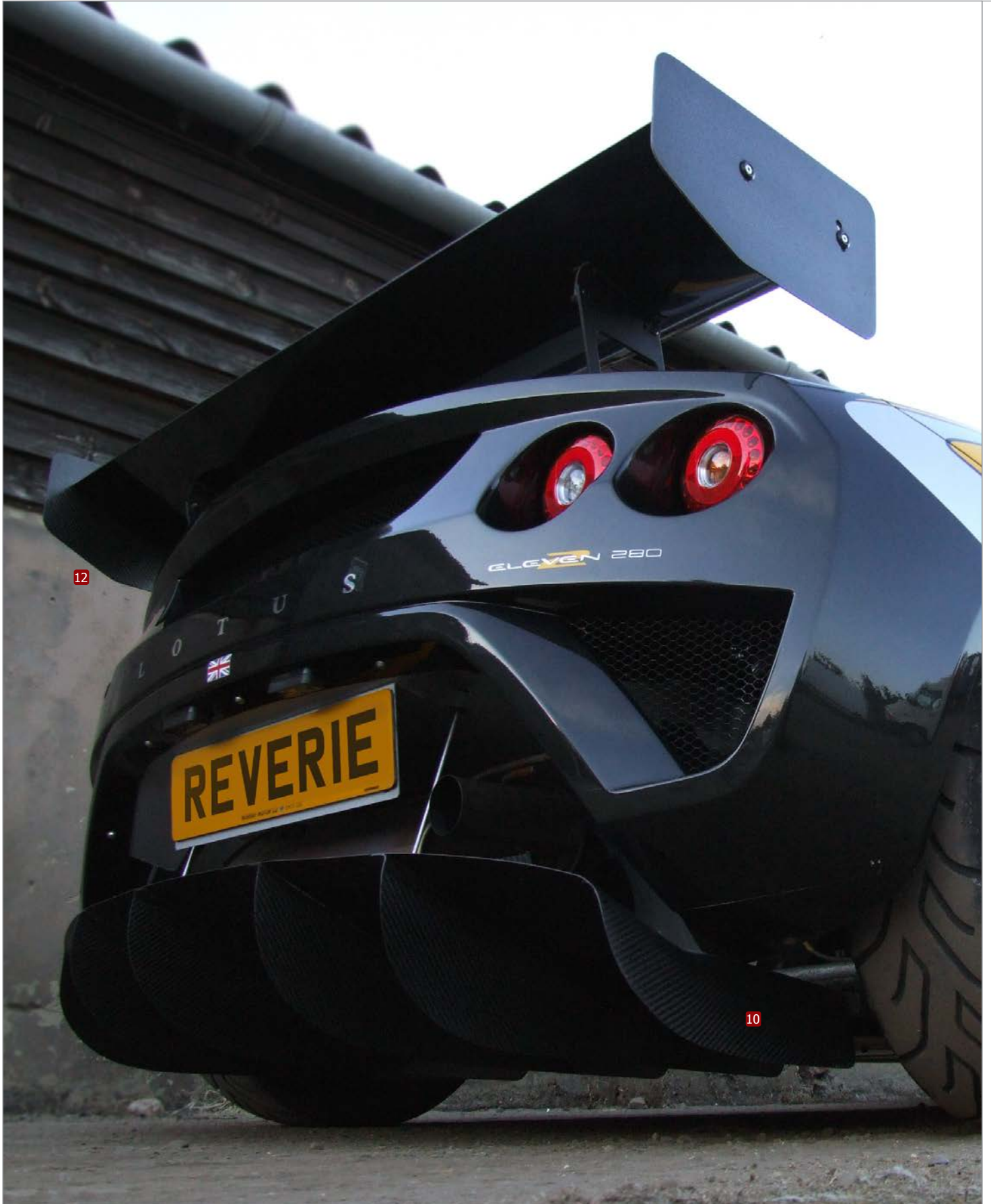

12

10



Direct OEM replacement using original fixings



LOTUS 340R

We manufacture a range of different parts for the Lotus 340R to enhance both performance and styling from rear wings and diffusers to dashboard panels and centre consoles.



For track use only, this front spoiler offers weight reduction compared to the standard OEM part. The deep version is 25mm deeper & offers improved down force over the standard spoiler. The kit features front spoiler with splitter plate and Gurney end plates with brake cooling ducts.



Part No.	ENGINE	£ (Ex. VAT)
1	R01SE0508 Engine Cam/Rocker Cover Carbon Fibre	£292.95
2	R01SE0169 Engine Spark Plug Cover Carbon Fibre	£159.00
EXTERIOR - SPLITTERS/SPOILERS		
3	R01SB0053 Front Splitter Carbon Fibre	£249.00
	R01SB0051 Front Spoiler Kit - Deep Version, Carbon Fibre	£1795.00
4	R01SB0107 Front Spoiler Kit - Standard Version, Carbon Fibre	£1836.45
	R01SB0052 Front Spoiler Kit - Deep Version, GRP	£1395.00
	R01SB0108 Front Spoiler Kit - Standard Version, GRP	£1521.45
EXTERIOR - DIFFUSERS		
5	R01SB0339 Rear Diffuser - Std Length	£419.00
6	R01SB0340 Rear Diffuser - Medium Length	£495.00
7	R01SB0341 Rear Diffuser - Long Length	£529.00
8	R01SB0253 Rear Diffuser - 3 Element, Wide Mid-Floor	£870.45

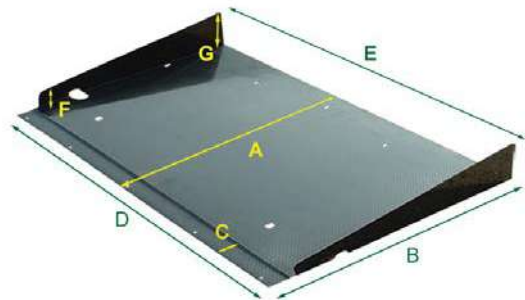
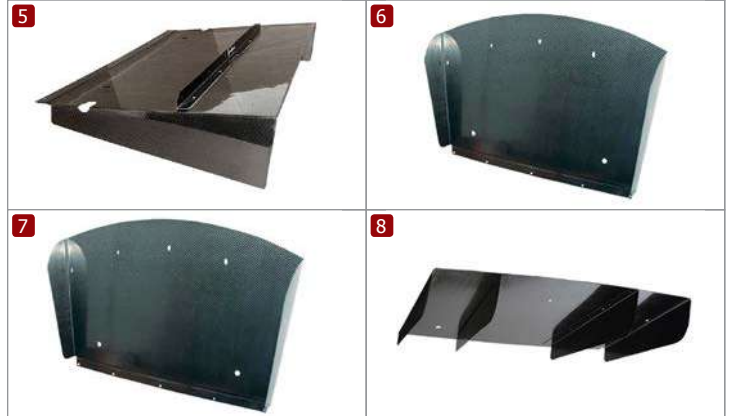

PART #	A	B	C	D	E	F	G
R01SB0339	540	540	35	810	890	55	120
R01SB0340	580	510	35	775	890	55	120
R01SB0341	690	620	35	775	910	55	120
R01SB0253	740	650	35	1180	1180	45	125





LOTUS 340R

Part No.	EXTERIOR - FLOOR SECTIONS	£ (Ex. VAT)
1 R01SB0323	Rear Floor Section Std. Carbon/Alloy Honeycomb 2 NACA Ducts	£799.00
R01SB0177	Rear Floor Panel Std. Carbon - 2 NACA Ducts	£699.00
2 R01SB0247	Rear Floor Section Wide Carbon - 2 NACA Ducts	£699.00
R01SB0322	Floor Panel Wide Alloy Honeycomb - 2 NACA ducts	£799.00
EXTERIOR - REAR WING KITS		
3 R01SB0190	Rear Wing Kit (Curved) - 225mm Chord x W960mm	£1049.00
4 R01SB0258	Rear Wing Kit (Straight) - 225mm Chord x W1240mm	£1312.50
5 R01SB0195	Rear Wing Kit (Curved) - 225mm Chord x W1650mm	£1363.95
6 R01SB0023	Rear Wing Supports Carbon/Nomex - Pair	£1095.00
7 R01SB0043	Wing Supports Carbon/Nomex 100mm Raised Pair	£1195.00
8 R01SB0050	Wing Supports Carbon/Nomex 230mm Raised Pair	£1258.95

1 2 Rear floor sections with Aluminium honeycomb that helps stiffen chassis and reduce rear toe change from sub frame flex when cornering hard. We recommend you also fit the motorsport rear toe link kit and a 6082 1" x 1/4" alloy flat bar stock brace between the rear toe link rose joint bolts across the sub frame. The wider width (1100mm) version fits under lower wishbones for lowered cars using low droop travel sports dampers and improves aerodynamics when used with a wider width rear diffuser. The rear floor section is fitted with 2 x NACA ducts (can be specified without) & exhaust manifold slot.

3 The curved 225mm wing is mounted to either Reverie Carbon Fibre adapter plates or to existing/new Carbon Nomex mounts (sold separately, items 6,7 & 8).

4 Straight 225mm wing that fits on standard alloy support mounts with supplied carbon 3mm height extension brackets which bolt to OEM alloy mounts (2 x M8). Supplied with Carbon drop tabs (980mm apart).

5 Curved 225mm wing that fits on standard alloy support mounts with supplied carbon 3mm extension brackets which bolt to OEM alloy mounts (2 x M8). Supplied with Carbon drop tabs (960mm apart external-to-external).

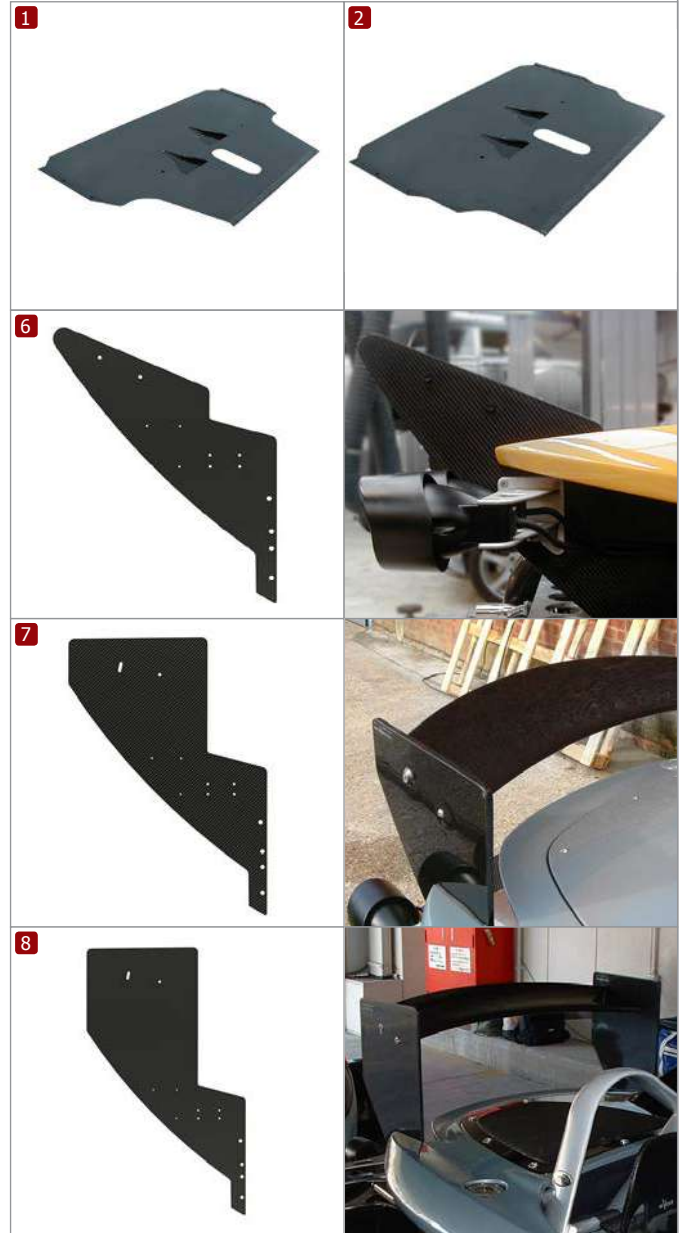



LOTUS 340R

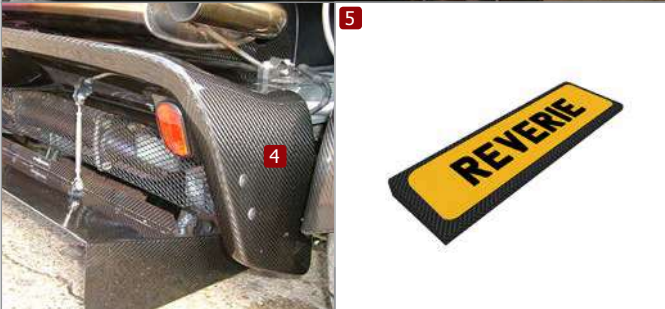
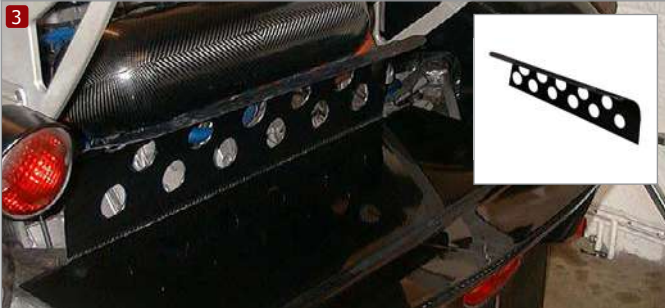

Part No.	EXTERIOR - OTHER	£ (Ex. VAT)
1	R01SB0012 Footwell Cooler Scoop Carbon Fibre	£628.95
2	R01SB0008 Rear Engine Cover w/Boost Tube Assembly Carbon	£1521.45
	R01SB0046 Rear Engine Cover w/Boost Tube Assembly GRP	£1307.25
3	R01SB0088 Rear Infill Exhaust Heatshield Panel Carbon Fibre	£579.00
4	R01SB0041 Rear Mid Spoiler Carbon Fibre	£1783.95
5	R01SB0118 Rear Number Plate Holder Carbon Fibre	£169.00
6	R01SB0089 Small Carbon Fibre Mid Spoiler Infill Panel	£219.00
	R01SB0103 Top Shell Guard Carbon - LH	£576.45
7	R01SB0104 Top Shell Guard Carbon - RH	£576.45

1 Footwell cooler scoop improves driver and passenger comfort by feeding cold ram-fed air into the footwell via the 50mm heater hose. Manufactured from lightweight Carbon Fibre, the cooler scoop is supplied ready to paint.

2 Bespoke designed 340R Carbon Fibre rear engine cover with ram air boost tube reduces intake temperature and increases the volume of air to the engine giving a power increase in excess of 6.9 BHP over a standard specification car.

7 LH/RH top shell guard provides protection for the clamshell upon entry and exit. Manufactured from Autoclaved Carbon Fibre for superior rigidity, lightness and finish. These can be used to hide a split in the rear clamshell if the rear engine cover is cut neatly off to make removal easier. You will then need to purchase and source separately 4 off 1/4 turn Camlock male studs and recetacles to suit the panel thickness's and neatly self fit etc. Otherwise they can be bolted under the mirrors at the front and held down at the rear with sikaflex or strong d/sided tape or special Velcro to provide protective anti scuff covers. Polished finish is gloss and hard wearing but non UV proof, clear coated on-cost options will be UV proof but may scratch.



Part No.	INTERIOR	£ (Ex. VAT)
1 R01SU0191	Centre Console/Tunnel - LHD Carbon Fibre	£314.95
R01SU0088	Centre Console/Tunnel - RHD Carbon Fibre	£314.95
2 R01SU0143	Centre Footwell Divider - LHD Carbon Fibre	£198.45
R01SU0141	Centre Footwell Divider - RHD Carbon Fibre	£198.45
3 R01SU0041	Dash Top/Mat - LHD Carbon Fibre	£124.95
R01SU0030	Dash Top/Mat - RHD Carbon Fibre	£124.95
4 R01SE0285	Rear 12v Carbon Fibre Electric Socket Cover	£209.95

LOTUS 340R





LOTUS ELISE S1



Carbon Fibre HT lead cover for early K-Series engines. Replacement for OEM part



Carbon Fibre front spoiler increases down-force reducing front end lift at high speeds. Available painted to the colour of your car at extra cost



Carbon Fibre splitter plate that can be used with or without front spoiler. Provides additional down-force by improving air flow underneath the car

Part No.	ENGINE	£ (Ex. VAT)
1 R01SE0205	Carbon Air Induction Kit - (D230CX)	£387.45
R01SE0274	Carbon/Alloy Air Induction Kit - (D230C)	£334.95
2 R01SE0268	Air Filter Induction Kit - Alloy	£261.45
3 R01SE0412	Honda Engine Air Induction Kit - Ducted	£376.95
4 R01SE0508	Engine Cam/Rocker Cover for K-Series Carbon	£292.95
5 R01SE0169	Engine Spark Plug Cover Carbon Fibre	£159.00
EXTERIOR - SPLITTERS/SPOILERS		
6 R01SB0057	Lotus Elise S1 Carbon Fibre Front Spoiler	£799.00
7 R01SB0102	Lotus Elise S1 Carbon Fibre Front Splitter	£271.95





LOTUS ELISE S1

Part No. EXTERIOR - DIFFUSERS

£ (Ex. VAT)

- 1** R01SB0045 Single Element, Std Length £349.00
- 2** R01SB0120 Single Element, Medium Length £429.00
- 3** R01SB0055 Single Element, Long Length £419.00
- 4** R01SB0056 3 Element, Long Length £549.00
- 5** R01SB0128 5 Element, Long Length £649.95

EXTERIOR - FLOOR SECTIONS

- 6** R01SB0323 Rear Floor Section Std. Carbon/Alloy 2 NACA Ducts £799.00
- R01SB0177 Rear Floor Panel Std. Carbon - 2 NACA Ducts £699.00
- R01SB0247 Rear Floor Section Wide Carbon - 2 NACA Ducts £699.00
- 7** R01SB0322 Floor Panel Wide Alloy Honeycomb - 2 NACA ducts £799.00
- R01SB0178 Front Floor Section Carbon Fibre £156.45

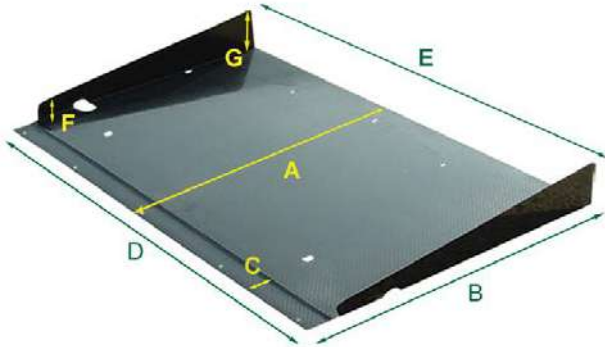

PART #	A	B	C	D	E	F	G
R01SB0045	540	540	35	810	890	55	120
R01SB0120	580	510	35	775	890	55	120
R01SB0055	690	620	35	775	910	55	120
R01SB0056	690	620	35	775	910	55	120
R01SB0128	690	620	35	775	910	55	120

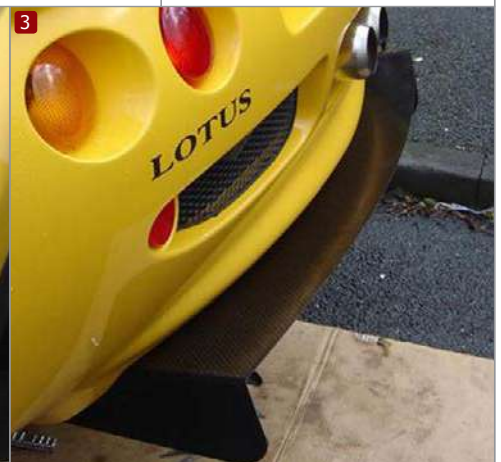
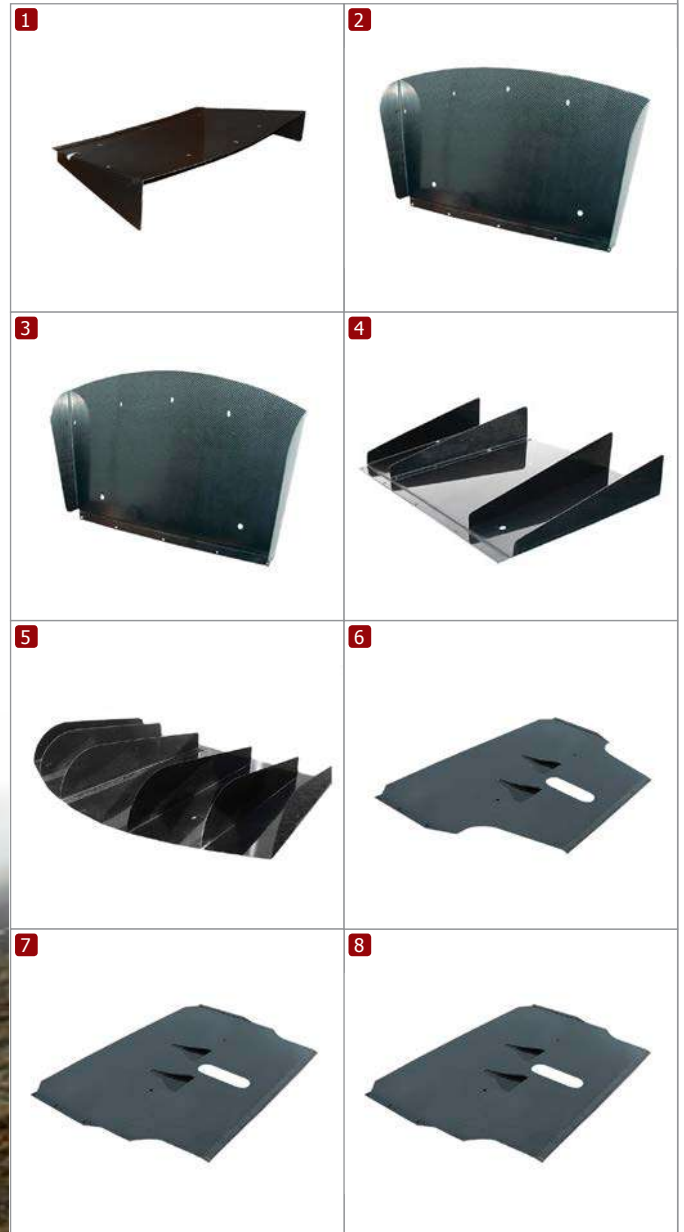



LOTUS ELISE S1

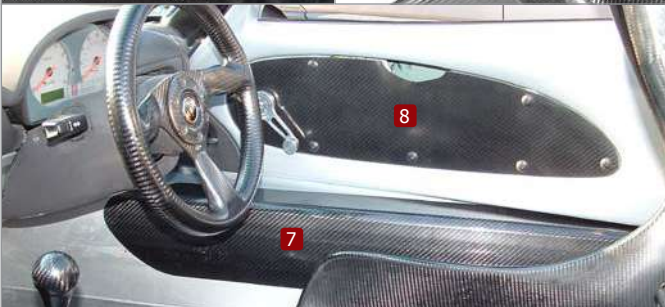
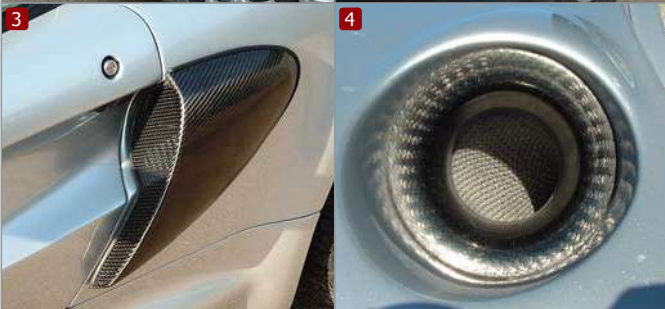

Part No.	EXTERIOR - OTHER	£ (Ex. VAT)
1 R01SB0100	Hard Top Assembly Carbon Fibre	£1710.45
R01SY0019	Hard Top Carry Bag	£208.95
2 R01SB0152	Front Tyre Deflectors Carbon Fibre - Pair	£62.59
3 R01SE0378	Side Intake Scoops Carbon Fibre - Pair	£376.95
4 R01SE0386	Air Intake Trumpet Funnel/Brake Duct - 58mm Outlet Carbon	£88.19
INTERIOR		
R01SU0143	Carbon Fibre Centre Footwell Divider - LHD	£198.45
5 R01SU0141	Carbon Fibre Centre Footwell Divider - RHD	£198.45
R01SU0192	Carbon Fibre Centre Tunnel - LHD 340R Style	£314.95
6 R01SU0140	Carbon Fibre Centre Tunnel - RHD 340R Style	£314.95
7 R01SB0130	Carbon Fibre Over-Chassis Sill Protector Cover - Pair	£250.95
8 R01SU0142	Carbon Fibre Door Panels/ Cards - Pair	£188.95

1 Carbon Fibre hardtop component and assembly. Enhances the looks of the S1 Elise and provides the added benefit of extra security. Easy to fit and lightweight, the hard top has a bespoke carry bag (sold separately) to store the top when not needed.

3 Polished Autoclaved Carbon Fibre side air intake scoops for the Lotus Elise S1 (96 - 01). The deep scoop provides an increase in the amount of air provided to the engine, increasing performance. Easy fitment/removal incorporating fitment tabs, the side scoops are supplied with durable black anodised aluminium grilles. Supplied as a pair.





Part No.	REAR WINGS	£ (Ex. VAT)
1 R01SB0122	150mm Chord x W1450mm Straight Adjustable	£1044.75
2 R01SB0213	150mm Chord x W1450mm Curved Adjustable Clam Mount	£996.45
3 R01SB0159	225mm Chord x W1245mm Curved Adjustable Clam Mount	£1153.95

Our bespoke Lotus Elise S1 (96 - 01) Carbon Fibre rear wing kits are specially designed to provide increased down-force and performance. For best results, it is best to utilise our rear wings with a front spoiler and rear diffuser (or similar device). When used with our front spoiler & 5-Element rear diffuser, a rear wing angle of attack set-up of 10deg provides a good aerodynamic balance.

LOTUS ELISE S1



Adjusted by the four rose jointed carbon support posts





LOTUS ELISE S2



see [page 19](#) item 18 for scoop



for non-supercharged engine

for supercharged engine



for K-Series engine

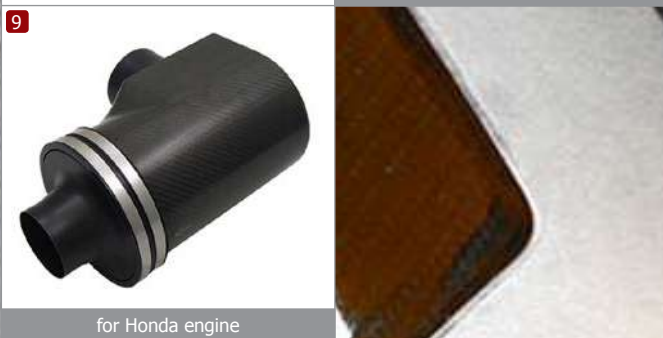

for Honda engine

Part No.	ENGINE (2ZZ-GE in 111R)	£ (Ex. VAT)
1	R01SE0276 Non-Ducted Alloy Air Induction Kit (D230A)	£303.45
2	R01SE0277 Non-Ducted Carbon Air Induction Kit (D230C)	£366.45
3	R01SE0278 Ducted Air Induction Kit (D230CX)	£418.95
4	R01SE0284 Spark Plug Cover	£189.00
5	R01SE0283 Engine Cover Carbon (Non-Supercharged)	£179.00
6	R01SE0441 Engine Cover Carbon	£189.00
ENGINE (for K-SERIES)		
7	R01SE0295 Engine Cam/Rocker Cover - for Elise 111S	£303.45
	R01SE0135 Engine Cam/Rocker Cover - Non-Elise 111S	£292.95
	R01SE0273 Induction Kit (Alloy Case/Alloy Adaptor)	£261.45
	R01SE0206 Induction Kit (Carbon Case/Carbon Adaptor)	£408.45
8	R01SE0275 Induction Kit (Carbon Case/Alloy Adaptor)	£334.95
ENGINE (HONDA POWERED)		
9	R01SE0412 Honda Engine Air Induction Kit - Ducted	£376.95

1 2 3 Fully tailored, ready to fit system for the Lotus Elise S2 111R, Exige S2 111R, 240R and 2-Eleven with the Toyota 2ZZ-GE engine. The kit is based on the popular Reverie Daytona 230 induction kit range. Designed to allow maximum throughput of cold clean induced air, when rolling road tested on a 111R a 7bhp gain was recorded with a total peak gain of 10.9bhp.

4 Carbon Fibre engine spark plug cover for the Toyota 2ZZ-GE (1.8L) VVTi engine as found in the Lotus Elise/Exige (inc. 111R, 111S, 240R, 240 Cup and 255). Replaces OEM engine cover using original fixings. Fully EMI shielded.

5 Polished Carbon Fibre engine cover for the Toyota 2ZZ-GE (1.8L) VVTi engine found in the Lotus Elise S2, Exige S2 and 111R. Not for supercharged versions of this engine. Replaces OEM part using original fixings, the engine cover is fully EMI shielded.

6 Drop in replacement polished Carbon Fibre injection cover modified for Lotus supercharged models (Lotus 2-Eleven, Elise SC, Exige S, 240R, 240 Cup and 255). Fully EMI shielded and fits in place using original fixings.

8 Fully tailored, ready to fit system for the Lotus Elise S2 (01 - 11) based on the popular Reverie Daytona 230 induction kit range. Designed to allow maximum throughput of cold, clean, induced air to the K-Series engine in the Elise. The 100mm bell mouth can be positioned just behind the LHS intake grille and when rolling road tested on a 139 BHP VVC Elise, gave 3.5bhp gains across RPM range. Increased performance can be achieved on more highly tuned cars.

9 Fully tailored, ready to fit air induction system for Honda engine Lotus Elise S1 (96 - 01), Elise S2 (01 - 11), Exige S1 (00 - 02) and Exige S2 (04 - 06) sports cars. Designed to allow maximum throughput of cold, clean, induced air to the engine improving performance and throttle response.





LOTUS ELISE S2

Part No.	EXTERIOR - DIFFUSERS	£ (Ex. VAT)
1 R01SB0040	Single Element	£469.00
2 R01SB0109	3 Element	£699.00
3 R01SB0110	5 Element	£799.00
4	EXTERIOR - DIFFUSERS for WIDE MID-FLOOR ONLY	
R01SB0253	3 Element, Undrilled, Wide Mid-Floor Only	£870.45
R01SB0251	3 Element, 3 Fixing Holes, Wide Mid-Floor Only	£870.45
R01SB0252	3 Element, 5 Fixing Holes, Wide Mid-Floor Only	£870.45
5	EXTERIOR - DIFFUSERS for 111R	
R01SB0092	3 Element, 3 Fixing Holes	£699.00
R01SB0217	3 Element, 5 Fixing Holes	£699.00
R01SB0318	3 Element, 7 Fixing Holes	£699.00
R01SB0112	3 Element, 3 Fixing Holes, Stage 2 Exhaust	£699.00
R01SB0218	3 Element, 5 Fixing Holes, Stage 2 Exhaust	£699.00
R01SB0319	3 Element, 7 Fixing Holes, Stage 2 Exhaust	£699.00
6	EXTERIOR - DIFFUSERS for 111S NO EXHAUST HOLE	
R01SB0039	3 Element, 3 Fixing Holes	£699.00
R01SB0254	3 Element, 3 Fixing Holes, No Heatshield	£699.00
R01SB0216	3 Element, 5 Fixing Holes	£699.00
R01SB0317	3 Element, 7 Fixing Holes	£699.00

We manufacture a range of Carbon Fibre rear diffuser for the Lotus Elise S2 up to 2010. Our diffusers are direct OEM replacements and offer improved down-force over the existing configuration. Different exhaust hole options are available (standard or stage 2) to accommodate variations in Elise S2 models. Our diffusers are heat shielded to reflect exhaust heat.

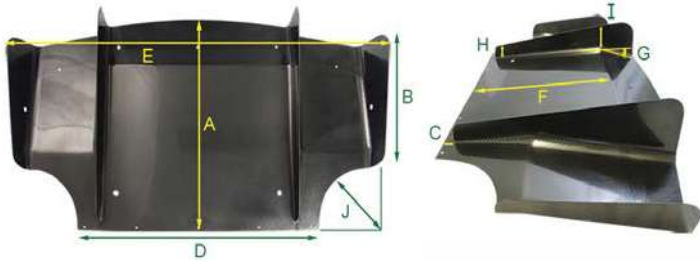

PART #	A	B	C	D	E	F	G	H	I	J
R01SB0040	690	395	30	790	1195	445	16	90	120	180
R01SB0109	690	395	30	790	1195	445	16	90	120	180
R01SB0110	690	395	30	790	1195	445	16	90	120	180
R01SB0039	680	410	30	785	1240	495	16	70	125	185
R01SB0254	680	410	30	785	1240	495	16	70	125	185
R01SB0091	680	410	30	785	1230	495	16	50	100	185
R01SB0251	740	650	35	1180	1180	N/A	N/A	45	120	N/A



<p>1</p> <p>fits standard car, 2.0kg</p>	
<p>2</p> <p>fits standard car, 2.3kg</p>	
<p>3</p> <p>fits standard car, 2.5kg</p>	
<p>4</p> <p>fits all models, 3.2kg</p>	<p>shown on Elise S1</p>
<p>5</p> <p>for 111R, 2.5kg</p>	
<p>6</p> <p>for 111S, 2.5kg</p>	



LOTUS ELISE S2



For use with three element diffuser R01SB0251/2/3



AoA Adjustable mount posts

Can be used with high-level mounts



Can be used with high-level mounts



Top-mounted wing

Non-adjustable



Top-mounted wing

11



Part No.	EXTERIOR - MID FLOORS STD. WIDTH	£ (Ex. VAT)
R01SB0177	Carbon 2 x NACA Ducts (K-Series)	£699.00
R01SB0323	Carbon/Alloy Honeycomb 2 x NACA Ducts (K-Series)	£799.00
1 R01SB0180	Carbon 3 x NACA Ducts (111R)	£799.00
R01SB0325	Carbon/Alloy Honeycomb 3 x NACA ducts (111R)	£799.00
	EXTERIOR - MID FLOORS WIDE WIDTH	
R01SB0247	Carbon 2 x NACA Ducts (K-Series)	£699.00
R01SB0322	Carbon/Alloy Honeycomb 2 x NACA ducts (K-Series)	£799.00
2 R01SB0248	Carbon 3 x NACA Ducts (111R)	£799.00
R01SB0324	Carbon/Alloy Honeycomb 3 x NACA ducts (111R)	£799.00
	EXTERIOR - REAR WINGS KITS CURVED	
3 R01SB0095	150mm Chord x W1450mm, Adjustable Supports	£1044.75
4 R01SB0215	150mm Chord x W1245mm, Adjustable Clam	£1048.95
5 R01SB0160	225mm Chord x W1650mm, Adjustable Clam	£1595.00
6 R01SB0386	225mm Chord Drop-End x W1240, Adjustable Clam	£1678.95
7 R01SB0534	225mm Chord x W1650 with Swan Top Mounts	£2098.95
	EXTERIOR - REAR WINGS KITS STRAIGHT	
8 R01SB0119	150mm Chord x W1450mm, Fixed	£1044.75
9 R01SB0533	310mm Chord Low Drag x W1650mm Swan Top Mounts	£2098.95
	EXTERIOR - REAR WINGS ACCESSORIES	
10 R01SB0551	Rear Wing Internal Clam Mounting Kit only	£398.00
11 R01SB6039	12mm Alloy High Level Wing Support - Black (Each)	£124.95

Rear floor sections with Aluminium honeycomb that helps stiffen chassis and reduce rear toe change from sub frame flex when cornering hard. We recommend you also fit the motorsport rear toe link kit and a 6082 1" x 1/4" alloy flat bar stock brace between the rear toe link rose joint bolts across the sub frame. The wider width (1100mm) version fits under lower wishbones for lowered cars using low droop travel sports dampers and improves aerodynamics when used with a wider width rear diffuser. The rear floor section is fitted with 2 x NACA ducts (can be specified without) & exhaust manifold slot.

Our bespoke Lotus Elise S2 Carbon Fibre rear wing kits are specially designed to provide increased down-force and performance. For best results, it is best to utilise our rear wings with a front spoiler and rear diffuser (or similar device).





LOTUS ELISE S2

Part No.	EXTERIOR - SPOILERS/SPLITTERS	£ (Ex. VAT)
1 R01SB0125	Carbon Fibre Front Spoiler - Integrated Splitter Plates	£699.00
2 R01SB0101	Carbon Fibre Front Spoiler - Non-Splitter Plate Version	£669.00
3 R01SB0115	Front Spoiler Carbon Fibre Splitter Plates	£103.95
4 R01SB0212	Carbon Fibre Front Canards - Pair, Pre-2010	£250.95
EXTERIOR - OTHER		
5 R01SB0389	Bond-on Race Honeycomb Angled Radiator Mount Carbon Fibre	£943.95
6 R01SB0036	Boost Tube Intake Assembly Carbon Fibre	£1185.45
7 R01SE0296	111R/111S Carbon Fibre Side Intake Scoops - Pair	£389.00
8 R01SE0294	111R/111S Carbon Fibre Side Intake Scoop - LH	£208.95
9 R01SB0241	Front Wheel Arch Louvre Vents Carbon Fibre - Pair	£376.95
10 R01SB0242	Rear Wheel Arch Louvre Vents Carbon Fibre - Pair	£376.95

1 2 Direct replacement, lightweight Carbon Fibre front spoiler to fit the Lotus Elise S2 yielding increased down-force and reduced drag compared with standard OEM part. Available with or without splitter plates (bond-on splitter plates available separately).

4 Polished Carbon Fibre bumper canards are a tunable down-force aid that fit below the headlamps. You can trim the width to reduce down-force as required. Supplied as a pair (LH & RH).

5 For fitment of custom angled mount radiator to reduce lift normally caused by pressure delta over standard Lotus flat mounted radiator, also gives improved cooling efficiency. Requires removal of original GRP Lotus crash structure from the chassis and also requires separate intake cowl to mate with clam shell (not currently available from us). TRACK/RACE USE ONLY. This unit has not undergone crash development or testing.

6 Carbon Fibre boost tube assembly reduces intake temperature and increases the volume of air available to the engine, giving increased power output. Sits outboard of the UK passenger side C-pillar, picking up cold dense high velocity air. Causes no restriction to opening the engine cover and has minimal impact on aerodynamic drag, the kit includes a non-filtered cowl ring & features 45deg 100mm outlet duct at the base. We are able to arrange painting of the boost tube for a competitive price, please contact us before ordering.

7 Carbon Fibre side air intake scoops designed as a direct replacement for the OEM scoops. Deeper scoop than the standard scoop increases the air intake to the engine. Easy fitment/removal incorporating fitment tabs. Supplied with black anodised aluminium grilles.

8 For fitment to ram-feed air box or Reverie Daytona 230CX air induction kit, these stylish Carbon Fibre side scoops fit the Elise S2 111R & S. Left-hand version.

9 10 Carbon Fibre front wheel arch louvre vents to vent air pressure from the wheel arches. Sold in pairs.

















Front Rear



LOTUS ELISE S2

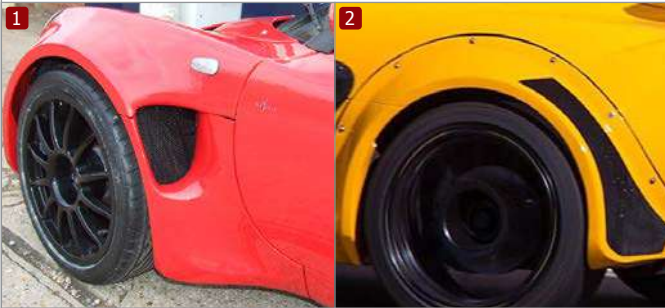

1 Internal flange (blended)

2 External flange

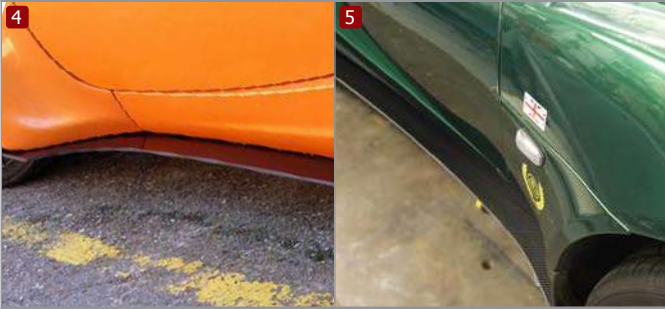

4 AoA Adjustable mount posts

5 for std. wheel arches

Part No.	EXTERIOR - GRP WHEEL ARCH KITS	£ (Ex. VAT)
R01SB0303	Full Wheel Arch Kit (External Flange) - 40/55mm	£1626.45
1 R01SB0300	Full Wheel Arch Kit (Internal Flange) - 40/55mm	£1626.45
R01SB0304	Front Wheel Arch Kit (External Flange) + 40mm	£943.95
R01SB0301	Front Wheel Arch Kit (Internal Flange)	£943.95
2 R01SB0305	Rear Wheel Arch Kit (External Flange) - 40/55mm	£838.95
R01SB0302	Rear Wheel Arch Kit (Internal Flange) - 40/55mm	£838.95
3 R01SB6026	Wheel Spacers - 30mm (4 x 100mm PCD)	£189.00
R01SB6025	Wheel Spacers - 40mm (4 x 100mm PCD)	£189.00
R01SB6042	Wheel Spacers - 50mm (4 x 100mm PCD)	£208.95
EXTERIOR - CARBON SILL EXTENSIONS		
4 R01SB0250	Pair for Reverie Front Arch Wheel Kits	£519.00
5 R01SB0249	Pair for Standard Wheel Arches	£519.00

Wet-lay GRP external flange front & rear wheel arches that increase the maximum allowable track width. Primed ready for painting to your car's colour. We are able to provide fitting and painting, please contact us first before ordering. Please specify between 40 or 55mm rear extension when ordering and hidden or external type flanges.

Polished Carbon Fibre horizontal sill extensions for the Lotus Elise S2 for use with either Reverie or standard front wheel arches. Tested in MIRA's wind tunnel, our sill extensions reduce leakage of pressure under the car, therefore increasing down-force and reducing drag. Works well when used with wider rear-mid floor section and rear diffuser with longer side tunnels to come under the rear wishbones. Sold as pair (LH + RH), the sill extensions are riveted and bolted in place with the fixings provided.



Blended internal flange example



3 Wheel spacers available from 30 - 50mm



Part No. INTERIOR

£ (Ex. VAT)

1	R01SU0223 Carbon Fibre Centre Tunnel - LHD (Toyota Engine)	£314.95
	R01SU0220 Carbon Fibre Centre Tunnel - RHD (Toyota Engine)	£314.95
2	R01SU0224 Carbon Fibre Centre Tunnel - LHD (K-Series)	£314.95
	R01SU0219 Carbon Fibre Centre Tunnel - RHD (K-Series)	£314.95
3	R01SU0214 Door Panels/Cards & Handles - Carbon Fibre Pair	£398.95
4	R01SU0221 Rear Electrical Carbon Cover for Tunnel (Toyota Engine)	£198.45
5	R01SU0143 Carbon Fibre Centre Footwell Divider - LHD (01 - 10)	£198.45
	R01SU0141 Carbon Fibre Centre Footwell Divider - RHD (01 - 10)	£198.45
6	R01SB0350 Carbon Centre Footwell Divider Lotus Elise (10 - 11)	£166.95

1 2 Polished Carbon Fibre centre console/tunnel for the Lotus Elise 111R cars with the Toyota ZZ engine with 6 speed gear box. Direct replacement for OEM part, note; you will need to add your own heated window and central locking unlock switch holes to the top if required.

3 Direct replacement Carbon Fibre door card set including handles manufactured from high quality Autoclaved Carbon Fibre for superior finish.

LOTUS ELISE S2

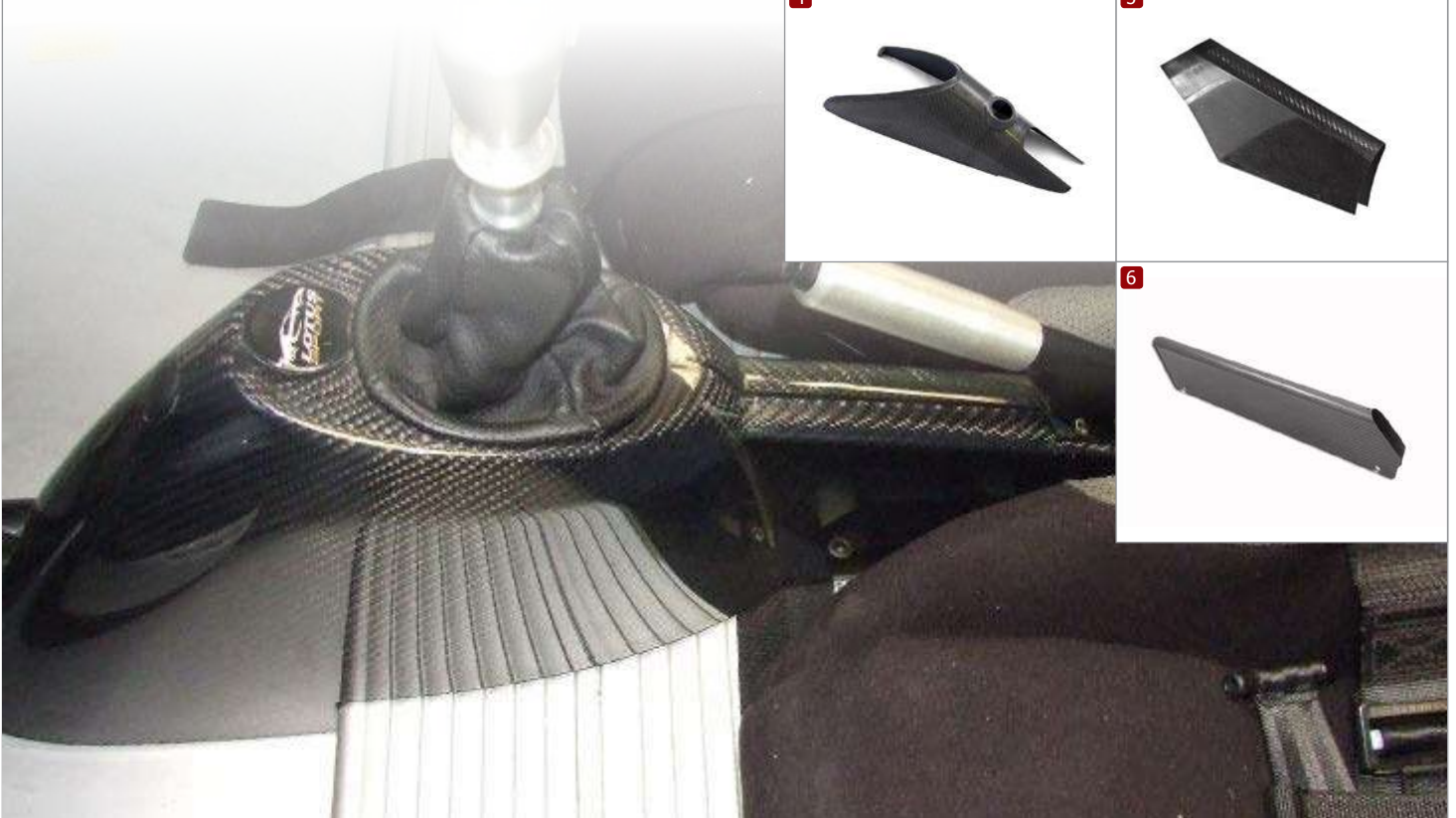

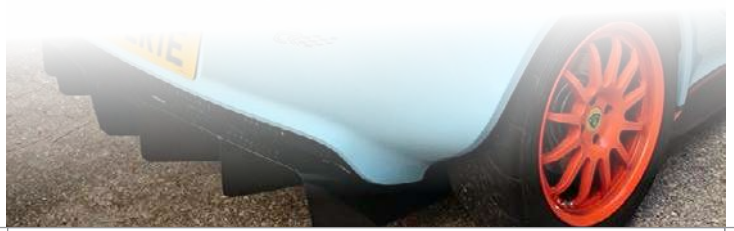

LOTUS ELISE S3

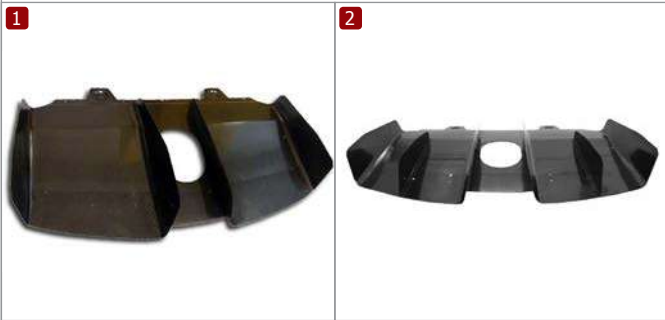

Part No. REAR DIFFUSERS

£ (Ex. VAT)

- 1** R01SB0420 Carbon Fibre Rear Diffuser - 3 Element £943.95
 - 2** R01SB0452 Carbon Fibre Rear Diffuser - 5 Element £1080.45
- REAR WING KITS**
- 3** R01SB0215 150mm Chord x W1245mm (Curved) Adjustable Clam £1048.95
 - 4** R01SB0160 225mm Chord x W1650mm (Curved) Adjustable Clam £1595.00
 - 5** R01SB0534 225mm Chord x W1650 (Curved) with Swan Mounts £2098.95
 - 6** R01SB0509 225mm Chord x W1300mm (Straight) for S3 250 Cup £1359.75
 - 7** R01SB0533 310mm Chord Low Drag x W1650mm + Swan Mounts £2098.95
- OTHER**
- 8** R01SB0249 Carbon Sill Extensions £519.00

1 2 Specially designed Carbon Fibre 3 & 5 element rear diffuser to fit the latest Lotus Elise S3 in production since 2011, this lightweight diffuser offers improved down-force compared with original part whilst having little effect on the vehicle's coefficient of drag. Diffuser vanes start earlier under the vehicle and extend further rearwards and lower down to give better performance and looks. This diffuser is a bolt-on replacement and all fixings are supplied.

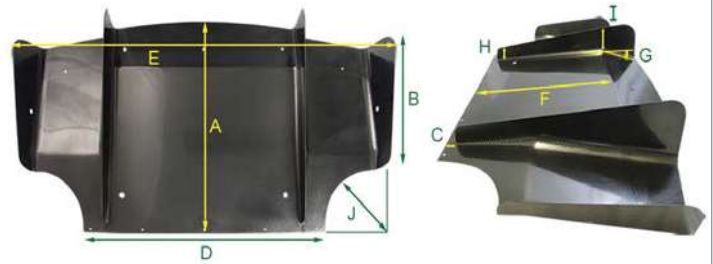

PART #	A	B	C	D	E	F	G	H	I	J
R01SB0420	590	460	35	970	1240	160	N/A	40	75	N/A
R01SB0452	590	460	35	970	1240	160	N/A	40	75	N/A



LOTUS EVORA

Part No. EVORA CARBON REAR DIFFUSER

£ (Ex. VAT)

- 1** R01SB0359 Evora Standard - 5 Element £799.00
- 2** R01SB0360 Evora S/Sport Pack - 3 Element £819.00

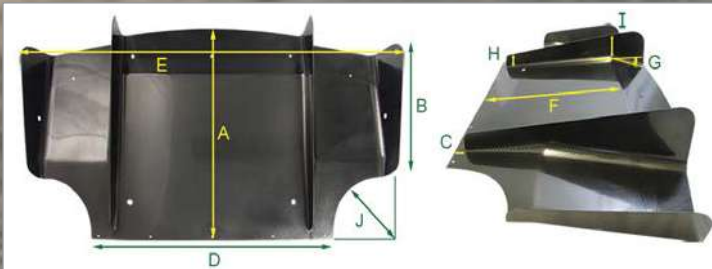

PART #	A	B	C	D	E	F	G	H	I	J
R01SB0420	590	460	35	970	1240	160	N/A	40	75	N/A
R01SB0452	590	460	35	970	1240	160	N/A	40	75	N/A

LOTUS EXIGE S1

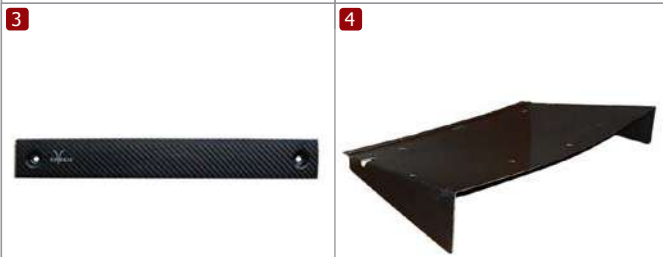

Carbon Fibre HT lead cover for early K-Series engines. Replacement for OEM part

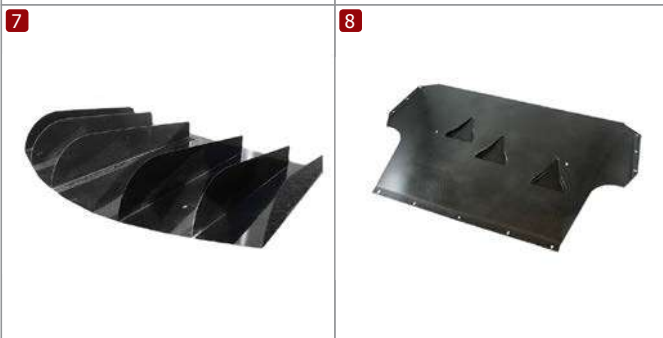

Part No. ENGINE £ (Ex. VAT)

- 1 R01SE0412 Honda Engined Air Induction Kit - Ducted £376.95
- 2 R01SE0508 Engine Cam/Rocker Cover for K-Series Carbon £292.95
- 3 R01SE0169 Engine Spark Plug Cover Carbon Fibre £159.00

EXTERIOR - DIFFUSERS

- 4 R01SB0349 Standard £419.00
- 5 R01SB0082 Single Element, Long Version £419.00
- 6 R01SB0083 3 Element, Long Version £549.00
- 7 R01SB0129 5 Element, Long Version £649.95

EXTERIOR - FLOOR SECTIONS

- 8 R01SB0323 Rear Floor Section Std. Carbon/Alloy 2 NACA Ducts £799.00
- R01SB0177 Rear Floor Panel Std. Carbon - 2 NACA Ducts £699.00
- 9 R01SB0247 Rear Floor Section Wide Carbon - 2 NACA Ducts £699.00
- R01SB0322 Floor Panel Wide Alloy Honeycomb - 2 NACA ducts £799.00

EXTERIOR - SPLITTERS/SPOILERS

- 10 R01SB0199 Carbon Fibre Front Splitter £199.00

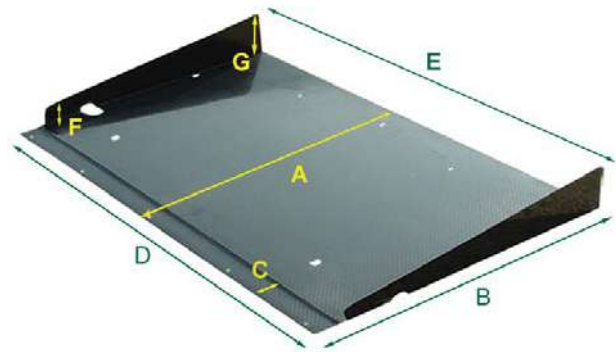

PART #	A	B	C	D	E	F	G
R01SB0349	540	540	35	810	890	55	120
R01SB0082	690	620	35	780	900	55	120
R01SB0083	690	620	35	780	900	55	120
R01SB0129	690	620	35	780	890	55	120



Part No.	EXTERIOR - REAR WINGS	£ (Ex. VAT)
1 R01SB0214	150mm Chord x W1650mm Curved Adjustable	£996.45
2 R01SB0183	225mm Chord x W1650mm Curved Adjustable	£1048.95
EXTERIOR - OTHER		
3 R01SE0378	Side Intake Scoops Carbon Fibre - Pair	£376.95
INTERIOR		
R01SU0143	Carbon Fibre Centre Footwell Divider - LHD	£198.45
4 R01SU0141	Carbon Fibre Centre Footwell Divider - RHD	£198.45
R01SU0192	Carbon Fibre Centre Tunnel - LHD 340R Style	£314.95
5 R01SU0140	Carbon Fibre Centre Tunnel - RHD 340R Style	£314.95
6 R01SB0130	Carbon Fibre Over-Chassis Sill Protector Cover - Pair	£250.95
7 R01SU0142	Carbon Fibre Door Panels/ Cards - Pair	£188.95

1 2 Our bespoke Lotus Exige S1 Carbon Fibre rear wing kits are specially designed to provide increased down-force and performance. For best results, it is best to utilise our rear wings with a rear diffuser (or similar device). When used with our 5-Element rear diffuser, a rear wing angle of attack set-up of 10deg provides a good aerodynamic balance.

3 Polished Autoclaved Carbon Fibre side air intake scoops for the Exige S1. The deep scoop provides an increase in the amount of air provided to the engine, increasing performance. Easy fitment/removal incorporating fitment tabs, the side scoops are supplied with durable black anodised aluminium grilles. Supplied as a pair.

LOTUS EXIGE S1

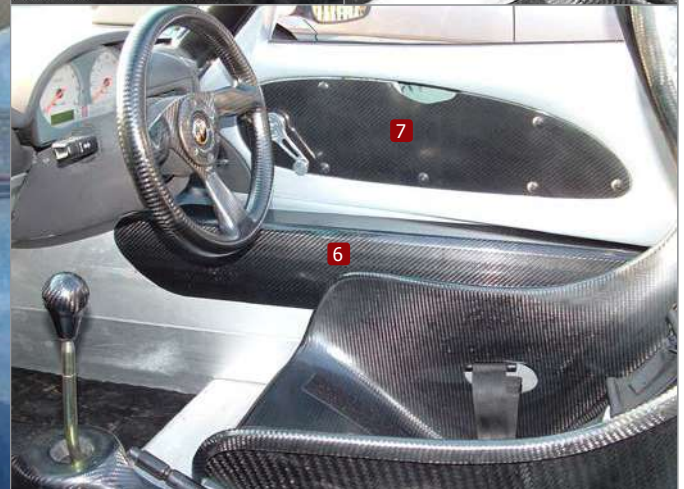

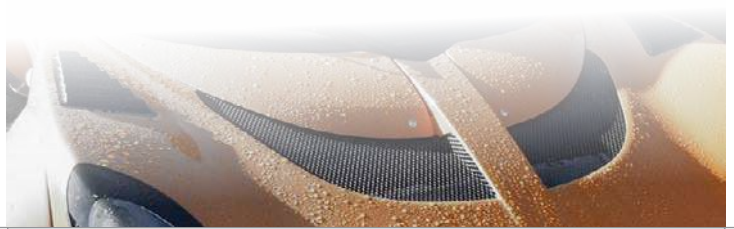

LOTUS EXIGE S2



Part No.	ENGINE (2ZZ-GE)	£ (Ex. VAT)
1	R01SE0276 Non-Ducted Alloy Air Induction Kit (D230A)	£303.45
2	R01SE0277 Non-Ducted Carbon Air Induction Kit (D230C)	£366.45
3	R01SE0278 Ducted Air Induction Kit (D230CX)	£418.95
4	R01SE0284 Spark Plug Cover	£189.00
5	R01SE0283 Engine Cover Carbon (Non-Supercharged)	£179.00
6	R01SE0441 Engine Cover Carbon	£189.00
ENGINE (HONDA POWERED)		
7	R01SE0412 Honda Engined Air Induction Kit - Ducted	£376.95
ENGINE - OTHER		
8	R01SB0124 Carbon Fibre Engine Bay Side Bulkhead Covers	£249.00

1 2 3 Fully tailored, ready to fit system for the Lotus Elise S2 111R, Exige S2 111R, 240R and 2-Eleven with the Toyota 2ZZ-GE engine. The kit is based on the popular Reverie Daytona 230 induction kit range. Designed to allow maximum throughput of cold clean induced air, when rolling road tested on a 111R a 7bhp gain was recorded with a total peak gain of 10.9bhp.

4 Carbon Fibre engine spark plug cover for the Toyota 2ZZ-GE (1.8L) VVTi engine as found in the Lotus Elise/Exige (inc. 111R, 111S, 240R, 240 Cup and 255). Replaces OEM engine cover using original fixings. Fully EMI shielded.

5 Polished Carbon Fibre engine cover for the Toyota 2ZZ-GE (1.8L) VVTi engine found in the Lotus Elise S2, Exige S2 and 111R. Not for supercharged versions of this engine. Replaces OEM part using original fixings, the engine cover is fully EMI shielded.

6 Drop in replacement polished Carbon Fibre injection cover modified for Lotus supercharged models (Lotus 2-Eleven, Elise SC, Exige S, 240R, 240 Cup and 255). Fully EMI shielded and fits in place using original fixings.

7 Fully tailored, ready to fit air induction system for Honda engined Lotus Elise S1 (96 - 01), Elise S2 (01 - 11), Exige S1 (00 - 02) and Exige S2 (04 - 06) sports cars. Designed to allow maximum throughput of cold, clean, induced air to the engine improving performance and throttle response.

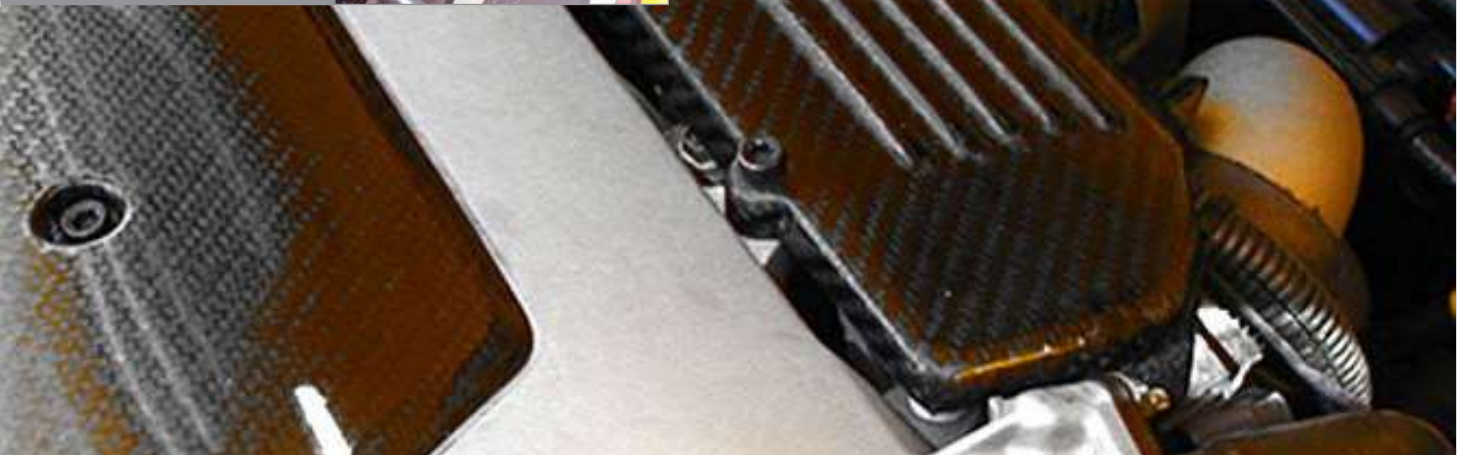



Part No.	EXTERIOR - DIFFUSERS	£ (Ex. VAT)
1 R01SB0040	Single Element	£469.00
2 R01SB0109	3 Element	£699.00
3 R01SB0110	5 Element	£799.00
4	EXTERIOR - DIFFUSERS for WIDE MID-FLOOR ONLY	
R01SB0253	3 Element, Undrilled, Wide Mid-Floor Only	£870.45
R01SB0251	3 Element, 3 Fixing Holes, Wide Mid-Floor Only	£870.45
R01SB0252	3 Element, 5 Fixing Holes, Wide Mid-Floor Only	£870.45
5	EXTERIOR - DIFFUSERS for 111R	
R01SB0092	3 Element, 3 Fixing Holes	£699.00
R01SB0217	3 Element, 5 Fixing Holes	£699.00
R01SB0318	3 Element, 7 Fixing Holes	£699.00
R01SB0112	3 Element, 3 Fixing Holes, Stage 2 Exhaust	£699.00
R01SB0218	3 Element, 5 Fixing Holes, Stage 2 Exhaust	£699.00
R01SB0319	3 Element, 7 Fixing Holes, Stage 2 Exhaust	£699.00
6	EXTERIOR - DIFFUSERS OTHER EXIGE S2	
R01SB0039	111R/220S - 3 Element, 3 Fixing Holes	£699.00
R01SB0219	111R/220S - 3 Element, 5 Fixing Holes	£699.00
R01SB0217	111R/240R - 3 Element, 5 Fixing Holes	£699.00
R01SB0218	111R/240R - 3 Element, 5 Fixing Holes, Stage 2 Exhaust	£699.00
R01SB0320	220S - 3 Element, 7 Fixing Holes	£699.00
7	EXTERIOR - DIFFUSERS for 260 CUP 2010	
R01SB0376	3-Element Rear Diffuser - No Exhaust Hole	£699.00
R01SB0372	3-Element Rear Diffuser - Std/Exhaust Hole	£699.00
R01SB0499	5-Element Rear Diffuser - Oval Exhaust Hole	£1044.75

LOTUS EXIGE S2

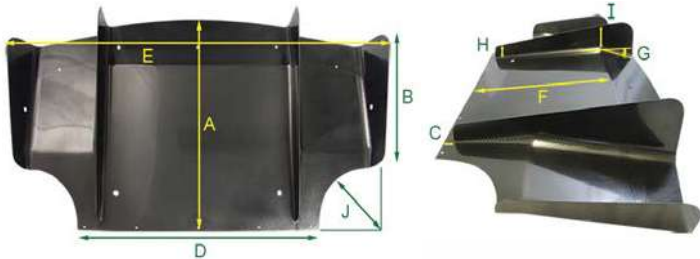

PART #	A	B	C	D	E	F	G	H	I	J
R01SB0039	680	410	30	785	1240	495	16	70	125	185
R01SB0376	580	420	30	820	1240	315	16	70	125	185
R01SB0092	680	410	30	785	1240	495	16	70	125	185
R01SB0112	680	410	30	785	1240	495	16	70	125	185
R01SB0219	680	410	30	785	1240	495	16	70	125	185
R01SB0372	580	410	30	820	1240	315	16	70	125	185
R01SB0253	740	650	35	1180	1180	N/A	16	70	120	N/A



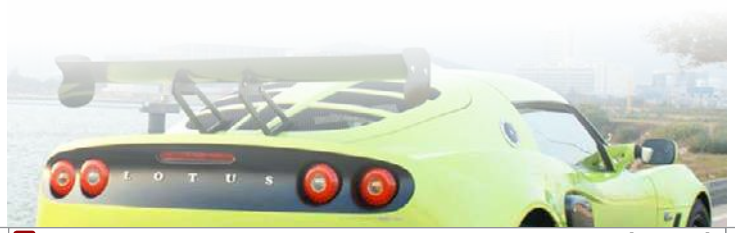

LOTUS EXIGE S2



For use with three element diffuser



Can be used with high-level mounts



Can be used with high-level mounts

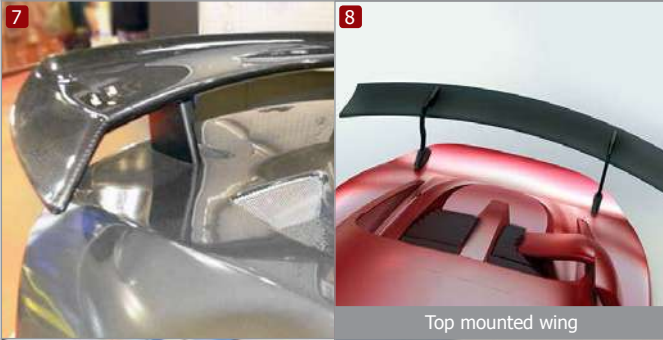

Top mounted wing



Top mounted wing

Part No.	EXTERIOR - MID FLOORS STD. WIDTH	£ (Ex. VAT)
R01SB0180	Carbon 3 x NACA Ducts	£799.00
R01SB0325	Carbon/Alloy Honeycomb 3 x NACA ducts	£799.00
2	EXTERIOR - MID FLOORS WIDE WIDTH	
R01SB0248	Carbon 3 x NACA Ducts	£799.00
R01SB0324	Carbon/Alloy Honeycomb 3 x NACA ducts	£799.00
EXTERIOR - MID FLOORS STD. WIDTH 260 CUP 2010 -		
R01SB0385	Carbon/Alloy Honeycomb	£899.00
R01SB0384	Carbon/Alloy Honeycomb - 2 x NACA Ducts	£949.00
EXTERIOR - MID FLOORS WIDE WIDTH 260 CUP 2010 -		
R01SB0377	Carbon/Alloy Honeycomb	£899.00
R01SB0373	Carbon/Alloy Honeycomb - 2 x NACA Ducts	£949.00
EXTERIOR - REAR WINGS KITS CURVED		
3 R01SB0215	150mm Chord x W1245mm, Adjustable Clam	£1048.95
4 R01SB0161	225mm Chord x W1000mm, Fixed	£1416.45
5 R01SB0236	225mm Chord x W1245mm, Adjustable Clam	£1468.95
6 R01SB0160	225mm Chord x W1650mm, Adjustable Clam	£1595.00
7 R01SB0386	225mm Chord Drop-End x W1240, Adjustable Clam	£1678.95
8 R01SB0534	225mm Chord x W1650 with Swan Top Mounts	£2098.95
9 R01SB0383	225mm Chord Motorsport Adjustable (10 - 11)	£1884.75
EXTERIOR - REAR WINGS KITS STRAIGHT		
10 R01SB0335	225mm Chord x W1245mm, Adjustable Clam	£1573.95
11 R01SB0533	310mm Chord L/ Drag x W1650mm Swan Top Mounts	£2098.95
EXTERIOR - REAR WINGS ACCESSORIES		
12 R01SB0551	Rear Wing Internal Clam Mounting Kit only	£398.00
13 R01SB6039	12mm Alloy High Level Wing Support - Black (Each)	£124.95
14 R01SB0192	Carbon Fibre Tailgate Wing Mount Covers - Pair	£345.45

Rear floor sections with Aluminium honeycomb that helps stiffen chassis and reduce rear toe change from sub frame flex when cornering hard. We recommend you also fit the motorsport rear toe link kit and a 6082 1" x 1/4" alloy flat bar stock brace between the rear toe link rose joint bolts across the sub frame. The wider width (1100mm) version fits under lower wishbones for lowered cars using low droop travel sports dampers. The rear floor section is fitted with 2 x NACA ducts (can be specified without) & exhaust manifold slot.



Lightweight and extremely rigid Carbon Fibre rear wing designed for motorsport applications to improve down-force. Autoclave cured for best properties and surface finish, the wing is lightweight & extremely rigid. The wing is adjustably mounted allowing you to fine tune the AoA. Includes mount kit and internal boot supports to transmit loads from the clam to the chassis/ boot floor.





Part No.	EXTERIOR - SPOILERS/SPLITTERS	£ (Ex. VAT)
1	R01SB0315 Front Race Spoiler (06 - 10)	£1095.00
2	R01SB0374 Front Race Spoiler (10 - 11)	£1195.00
3	R01SB0328 Front Spoiler - Bolt On, OEM Style	£479.00
4	R01SB0191 Std. Version w/Cutouts	£1049.00
4	R01SB0255 Std. Version - No Cutouts	£1049.00
5	R01SB0198 Wide Version w/Cutouts to suit Wide Arches	£1049.00
5	R01SB0256 Wide Version No Cutouts to suit Wide Arches	£1049.00
EXTERIOR - OTHER		
6	R01SB0212 Carbon Fibre Front Canards - Pair, Pre-2010	£250.95
7	R01SB0389 Bond-on Race Honeycomb Angled Radiator Mount Carbon Fibre	£943.95
8	R01SE0294 Carbon Fibre Side Intake Scoop - LH	£208.95
9	R01SE0280 Carbon Fibre Side Intake Scoops - Pair	£399.00
10	R01SB0193 Carbon Fibre Roof Scoop	£418.95
10	R01SB0194 GRP Roof Scoop	£313.95
11	R01SB0241 Front Wheel Arch Louvre Vents Carbon Fibre - Pair	£376.95
12	R01SB0242 Rear Wheel Arch Louvre Vents Carbon Fibre - Pair	£376.95

1 2 Direct replacement, lightweight Carbon Fibre front spoiler to fit the Lotus Exige S2 yielding increased down-force and reduced drag compared with standard OEM part. Available with or without splitter plates (bond-on splitter plates available separately).

6 Polished Carbon Fibre bumper canards are a tunable down-force aid that fit below the headlamps. You can trim the width to reduce down-force as required. Supplied as a pair (LH & RH).

7 For fitment of custom angled mount radiator to reduce lift normally caused by pressure delta over standard Lotus flat mounted radiator, also gives improved cooling efficiency. Requires removal of original GRP Lotus crash structure from the chassis and also requires separate intake cowl to mate with clam shell (not currently available from us). TRACK/RACE USE ONLY. This unit has not undergone crash development or testing.

8 For fitment to ram-feed air box or Reverie Daytona 230CX air induction kit, these stylish Carbon Fibre side scoops fit the Elise S2 111R & S. Left-hand version.

9 Carbon Fibre side air intake scoops designed as a direct replacement for the OEM scoops. Deeper scoop than the standard scoop increases the air intake to the engine. Easy fitment/removal incorporating fitment tabs. Supplied with black anodised aluminium grilles.



LOTUS EXIGE S2

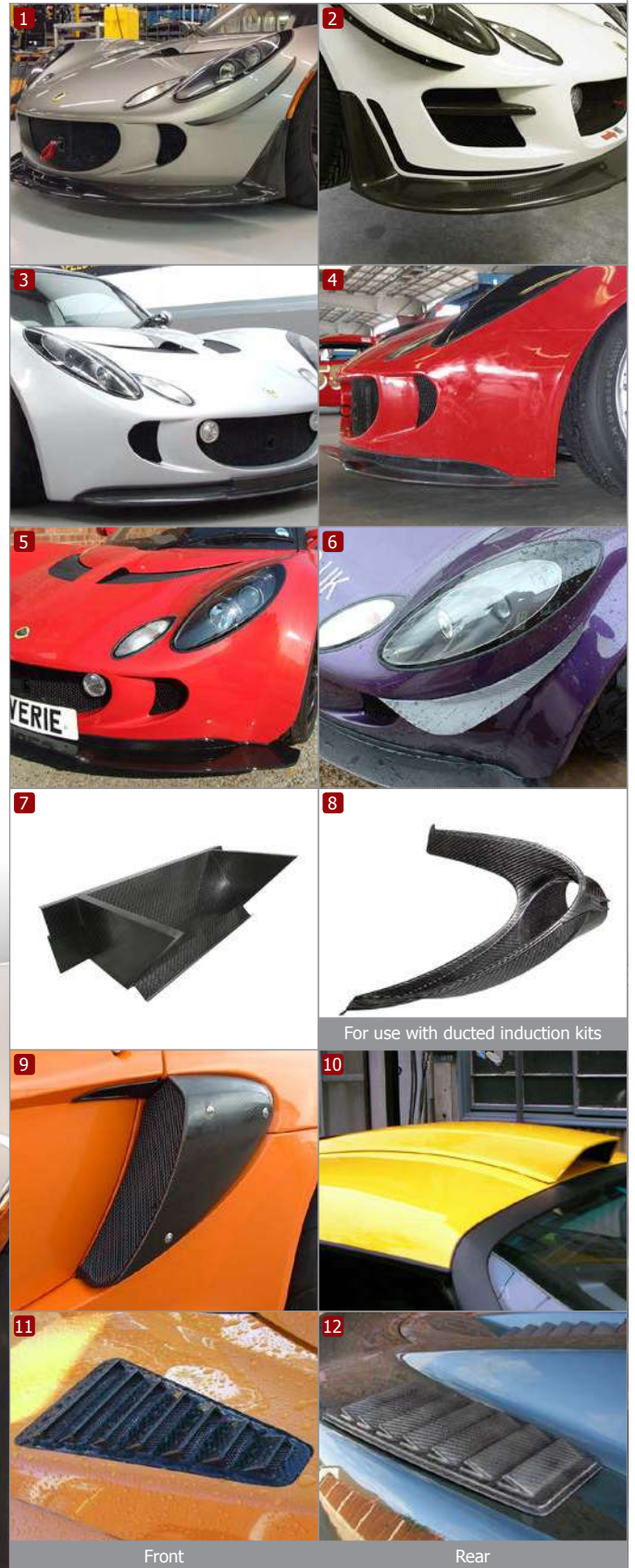

For use with ducted induction kits

Front

Rear



LOTUS EXIGE S2

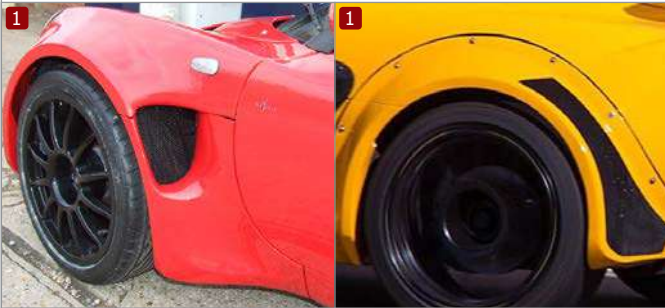

Internal flange (blended)

External flange



for Reverie wheel arches

for std. wheel arches



Part No.	EXTERIOR - GRP WHEEL ARCH KITS	£ (Ex. VAT)
R01SB0189	GRP Full Wheel Arch Kit (Ext. Flange) 40/55mm	£1626.45
R01SB0188	GRP Full Wheel Arch Kit (Int. Flange) 40/55mm	£1626.45
R01SB0185	GRP Front Wheel Arch Kit Pair (Ext. Flange)	£943.95
R01SB0153	GRP Front Wheel Arch Kit Pair (Int. Flange)	£943.95
R01SB0187	GRP Rear Wheel Arch Kit Pair (Ext. Flange) 40/55mm	£838.95
R01SB0186	GRP Rear Wheel Arch Kit Pair (Int. Flange) 40/55mm	£838.95
R01SB6026	Wheel Spacers - 30mm (4 x 100mm PCD)	£189.00
R01SB6025	Wheel Spacers - 40mm (4 x 100mm PCD)	£189.00
R01SB6042	Wheel Spacers - 50mm (4 x 100mm PCD)	£208.95
EXTERIOR - CARBON SILL EXTENSIONS		
R01SB0250	Pair for Reverie Front Arch Wheel Kits	£519.00
R01SB0249	Pair for Standard Wheel Arches	£519.00
EXTERIOR - OTHER		
R01SB0329	Carbon Fibre Tailgate/Hatch with Intercooler Vents	£1888.95
R01SB0353	Carbon Fibre Access Panels - Pair	£379.00

1 Wet-lay GRP external flange front & rear wheel arches that increase the maximum allowable track width. Primed ready for painting to your car's colour. We are able to provide fitting and painting, please contact us first before ordering. Please specify between 40 or 55mm rear extension when ordering and hidden or external type flanges.

3 Polished Carbon Fibre horizontal sill extensions for the Lotus Exige S2 for use with either Reverie or standard front wheel arches. Tested in MIRA's wind tunnel, our sill extensions reduce leakage of pressure under the car, therefore increasing down-force and reducing drag. Works well when used with wider rear-mid floor section and rear diffuser with longer side tunnels to come under the rear wishbones. Sold as pair (LH + RH), the sill extensions are riveted and bolted in place with the fixings



Wheel spacers available from 30 - 50mm



Part No. INTERIOR

£ (Ex. VAT)

1	R01SU0223	Carbon Fibre Centre Tunnel - LHD (Toyota Engined)	£314.95
	R01SU0220	Carbon Fibre Centre Tunnel - RHD (Toyota Engined)	£314.95
2	R01SU0214	Door Panels/Cards & Handles - Carbon Fibre Pair	£398.95
3	R01SU0221	Rear Electrical Carbon Cover for Tunnel (Toyota Engined)	£198.45
4	R01SU0143	Carbon Fibre Centre Footwell Divider - LHD (01 - 10)	£198.45
	R01SU0141	Carbon Fibre Centre Footwell Divider - RHD (01 - 10)	£198.45
5	R01SB0350	Carbon Centre Footwell Divider (10 - 11)	£166.95

1 Polished Carbon Fibre centre console/tunnel for cars with the Toyota ZZ engine with 6 speed gear box. Direct replacement for OEM part, note; you will need to add your own heated window and central locking unlock switch holes to the top if required.

3 Direct replacement Carbon Fibre door card set including handles manufactured from high quality Autoclaved Carbon Fibre for superior finish.

LOTUS EXIGE S2

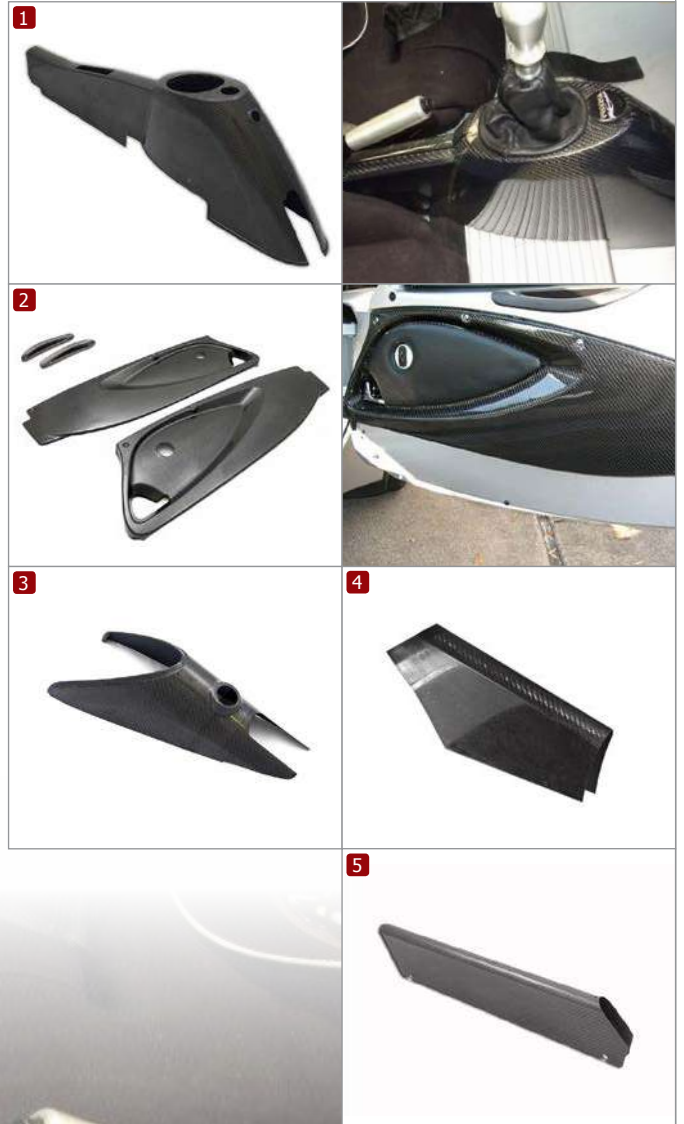

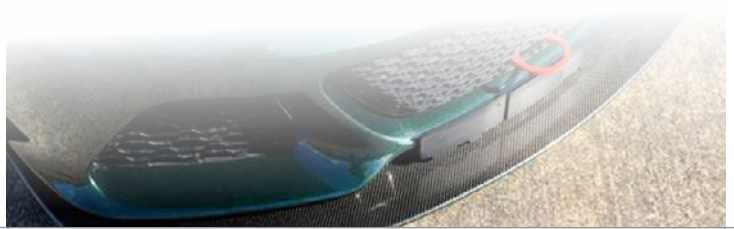

LOTUS EXIGE S3

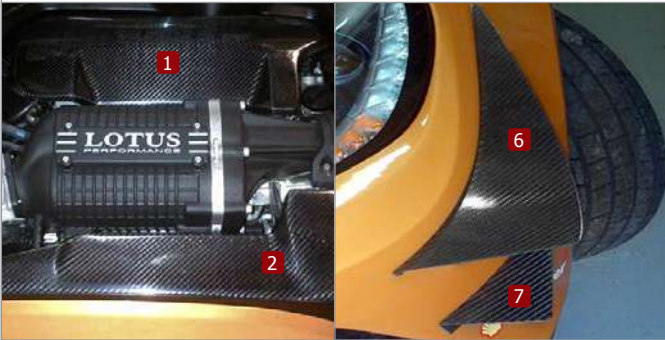

Part No.	ENGINE	£ (Ex. VAT)
1	R01SE0637 Carbon Fibre Front Engine Cam Cover	£299.00
2	R01SE0638 Carbon Fibre Rear Engine Cam Cover	£299.00
EXTERIOR		
3	R01SB0466 Carbon Fibre Side Intake Scoops - Pair	£699.00
4	R01SB0462 Carbon Fibre Side Skirt Sill Extensions - Pair	£559.00
5	R01SB0454 Carbon Fibre Front Splitter Assembly	£1299.00
6	R01SB0464 Carbon Fibre Bumper Canards Large - Pair	£313.95
7	R01SB0463 Carbon Fibre Bumper Canards Small - Pair	£261.45
8	R01SB0479 Carbon Replacement Mid-Floor Panel	£1006.95
9	R01SB0480 Carbon Replacement Wide Mid-Floor Panel	£1006.95
10	R01SB0475 Front Under-Floor Wishbone Carbon Infill Panel - LH	£119.00
11	R01SB0476 Front Under-Floor Wishbone Carbon Infill Panel - RH	£119.00
INTERIOR		
12	R01SU0214 Carbon Door Cards & Handles - Pair Round Electric Window	£398.95
13	R01SU0269 Carbon Door Cards & Handles - Oval Round Electric Window	£398.95

3 Carbon Fibre side air intake scoops designed as a direct replacement for the OEM scoops. Deeper scoop than the standard scoop increases the air intake to the engine. Easy fitment/removal incorporating fitment tabs. Supplied with black anodised aluminium grilles.

4 Carbon Fibre side skirt sill extensions are a bolt-on replacement for the Lotus Exige S3 V6 and are supplied as a left-hand and right-hand pair with rubber rivet nuts and M6 bolts. Fits standard clamshell with standard arches. Manufactured from high quality Autoclaved Carbon Fibre for superior rigidity and finish.

8 Replacement Carbon Fibre mid-floor panel for the Lotus Exige S3 V6. Standard width to fill in under the rear wishbones for cars with racing dampers with less droop travel to reduce drag and increase down-force.

12 13 Direct replacement Carbon Fibre door card set including handles manufactured from high quality Autoclaved Carbon Fibre for superior finish. NOTE: Some Exige V6 models have round electric window holes while some have oval holes in order to accommodate the different types of switches that were used in production. Check which type you have before ordering.

See page overleaf for rear wing kits

5 Front splitter assembly

3 Carbon side scoops

4 Carbon sill extensions



Part No. REAR DIFFUSERS

£ (Ex. VAT)

- 1** R01SB0465 Carbon Fibre Rear Diffuser Assembly - 5 Element £1080.45
 - 2** R01SB0482 Carbon Fibre Rear Diffuser Upper Grill Surround £549.00
- REAR WING KITS**
- 3** R01SB0471 225mm Chord x W1300mm Curved - Straight Mounts £1752.45
 - 4** R01SB0484 225mm Chord x W1300mm Curved - Swept Mounts £1783.95
 - 5** R01SB0490 225mm Chord x W1300mm Curved - 2-Eleven Style End Plates £1678.95
 - 6** R01SB0472 310HD Chord x W1700mm Straight Adjustable Clam Mounted £1878.95
 - 7** R01SB0469 310LD Chord x W1300mm Straight Straight Mounts £1678.95
 - 8** R01SB0583 310LD Chord x W1300mm Straight Swept Mounts £1778.95

LOTUS EXIGE S3

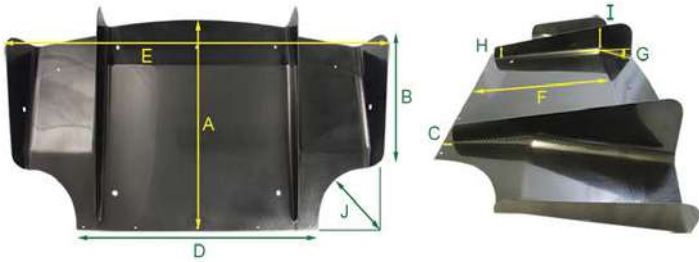

PART #	A	B	C	D	E	F	G	H	I	J
R01SB0465	640	460	85	860	1260	320	10	55	75	60



1



1 Rear diffuser - 5 element



2



3



5



6



8

7

>> [CLICK TO VIEW SEAT FITTING GUIDE](#)

>> [CLICK TO VIEW SEAT SIZE GUIDE](#)



BUCKET SEATS

We produce a range of autoclaved Carbon Fibre seats to fit Lotus cars from single skin (matt black finish on the rear) to twin skin (moulded polished front and back shells bonded together to make the ultimate stiff light monoque seats.

Our [FIA approved 8855-1999 Super Sports seats](#) have been sled impact tested in excess of 20G. FIA seats have the option of Velcro on trim pads or a fully trimmed seat front. A range of velcro-on seat cushions (in narrow or wide) or full seat trim options are available for use with the seats such as vinyl, FIA approved (fire resistant) spacer fabrics, Diminica genuine leather or Carbon Fibre embossed effect leather ([see from page 40](#)).

All of our side mounted seats feature 288-290mm standard side mount spacing.



BUCKET SEAT RANGE:



MULSANNE B/C

Lightweight seat available in either single or twin skin construction. ([page 35 - 36](#))



X C/XR C (N)

Narrow width untrimmed twin skin seat available in two distinct versions ([page 37](#))



SUPER SPORTS

Lightweight trimmed/untrimmed seat. FIA Approved versions of this seat are available ([page 38](#))



HR = Head Rest
 N/HR = Non-Head Rest
 * = FIA Approved 8855-1999

Part No.:	DESCRIPTION	KG	DIMENSION																	
			A	B	C	D	E	F	G	H	I	J	K	L	M	N	O	P	Q	X
R01SI0055	Mulsanne B Single Skin (Narrow, Low Back)	2.5	475	445	330	385	410	680	560	293	670	640	N/A	N/A	360	90	200	130	175	63
R01SI0017	Mulsanne B Single Skin (Narrow)	2.9	475	445	330	385	410	890	560	293	670	860	95	640	360	330	200	130	175	63
R01SI0015	Mulsanne C Twin Skin (Narrow, Low back)	2.4	470	440	330	380	410	680	540	286	680	630	N/A	N/A	360	90	230	130	175	60
R01SI0001	Mulsanne C Twin Skin (Narrow)	2.9	470	440	330	380	410	885	540	286	680	850	95	640	360	345	230	130	175	60
R01SI0104	Mulsanne CM Twin Skin (Narrow, Bottom Mounted)	2.5	430	400	330	320	400	840	640	286	700	830	90	600	345	330	240	N/A	N/A	60
R01SI0106	(FIA) Super Sports B Single Skin (Narrow, Trimmed)*	5.0	525	460	370	440	450	910	620	288	700	850	130	670	330	330	310	130	175	70
R01SI0091	(FIA) Super Sports Twin Skin (Narrow, Polished)*	4.4	490	440	330	420	430	910	630	288	700	880	150	655	340	330	310	130	175	65
R01SI0101	(FIA) Super Sports Twin Skin (Narrow, Trimmed)*	5.2	490	440	310	420	430	910	630	288	700	880	150	655	325	310	310	130	175	65
R01SI0107	Super Sports Twin Skin (Narrow, Polished)	4.4	490	440	330	420	430	910	630	288	700	880	150	655	340	330	310	130	175	65
R01SI0108	Super Sports Twin Skin (Narrow, Trimmed)	5.0	490	440	310	420	430	910	630	288	700	880	150	655	325	310	310	130	175	65
R01SI0047	X C Twin Skin (Narrow)	3.7	495	440	320	380	430	890	650	286	690	850	150	640	340	240	340	130	175	65
R01SI0036	XR C Twin Skin (Narrow)	3.6	500	440	330	380	470	890	640	286	690	850	140	640	340	250	340	130	175	65

>> [CLICK TO VIEW SEAT FITTING GUIDE](#)

>> [CLICK TO VIEW SEAT SIZE GUIDE](#)

SPECIFICATIONS

Dim.: [\(see page 34\)](#)
Weight: from 3.0KG
Material: Carbon Fibre
Fitment: Universal



For our range of cushion kits, see from [page 40](#)

For our range of side mounts, see [page 39](#)

MULSANNE B

> NARROW UNIVERSAL SEAT (SINGLE SKIN)

The Mulsanne B is a Carbon/glass composite single skin seat without a gloss moulded rear as an affordable entry level seat. It fits standard 288-290mm OMP/Sparco/Reverie/Cobra/Corbeau side mounts and our range of narrow velcro-on cushion kits. The Mulsanne B is a drop-in OEM replacement to standard subframes for the Lotus Elise S1/S2, 340R, 2-Eleven & Exige S1/S2.

Part No.	MULSANNE B BUCKET SEAT	£ (Ex. VAT)
1 R01SI0017	Mulsanne B	£702.45
2 R01SI0055	Mulsanne B Low Back Version	£749.00



The Mulsanne B weighs just 3.0KG

A range of seat mounts are available, see [page 39](#)



Mulsanne B in Lotus Elise

>> [CLICK TO VIEW SEAT FITTING GUIDE](#)

>> [CLICK TO VIEW SEAT SIZE GUIDE](#)



MULSANNE C

> NARROW UNIVERSAL SEAT (TWIN SKIN)

The Mulsanne C is a twin skin full pre-preg Carbon version of the Mulsanne B and features an ultra-stiff monocoque construction of two individual shells bonded together. The Mulsanne C fits standard 288-290mm OMP/Sparco/Reverie/Cobra/Corbeau side mounts and our range of narrow velcro-on cushion kits. The Mulsanne C is a drop-in OEM replacement to standard subframes for the Lotus Elise S1/S2, 340R, 2-Eleven & Exige S1/S2.

SPECIFICATIONS

Dim.: [\(see page 34\)](#)
 Weight: 2.4KG
 Material: Carbon Fibre
 Fitment: Universal

Part No.	MULSANNE C BUCKET SEAT	£ (Ex. VAT)
1 R01SI0001	Mulsanne C	£943.95
2 R01SI0015	Mulsanne C Low Back Version	£1038.45
3 R01SI0043	Bolt-on Side Impact Head Restraint	£450.45



Mulsanne C in Elise



Optimal head restraint fitted



For our range of cushion kits, see from [page 40](#)



For our range of side mounts, see [page 39](#)

>> [CLICK TO VIEW SEAT FITTING GUIDE](#)

>> [CLICK TO VIEW SEAT SIZE GUIDE](#)

SPECIFICATIONS

Dim.: [\(see page 34\)](#)

Weight: from 3.6KG

Material: Carbon Fibre

Fitment: Universal

X C/XR C

> NARROW UNIVERSAL SEATS

The X C and XR C narrow deep bucket supportive race seats have ultra stiff twin skin full pre-preg construction and fit standard 288-290mm OMP/Sparco/Reverie/Cobra/Corbeau side mounts and our range of narrow velcro-on cushion kits. Both the X C and XR C are also drop-in OEM replacements to standard subframes for the Lotus Elise S1/S2, 340R, 2-Eleven & Exige S1/S2. The XR C has a wrap-around head restraint for side impact protection.

Part No.	X C/XR C NARROW	£ (Ex. VAT)
1 R01SI0047	X C Untrimmed	£1038.45
2 R01SI0036	XR C Untrimmed	£1258.95



X C

XR C



X C

XR C



X C

XR C



For our range of cushion kits, see from [page 40](#)

For our range of side mounts, see [page 39](#)



The XR C features head restraints for side impact head protection



X C in Lotus 340R

Narrox XR C in Lotus Elise

>> [CLICK TO VIEW SEAT FITTING GUIDE](#)

>> [CLICK TO VIEW SEAT SIZE GUIDE](#)

SUPER SPORTS

> NARROW UNIVERSAL SEAT

The Super Sports is our most popular range of seats and is available in lightweight single skin Carbon/glass composite (with FIA spacer front trim) or ultra stiff twin skin pre-preg Carbon Fibre construction with front & rear polished shells. Three variants of the Super Sports seat are FIA 8855-1999 approved. All Super Sports seats fit standard 288-290mm OMP/Sparco/Reverie/Cobra/Corbeau side mounts and the twin skin can utilise our narrow velcro-on cushion kits or can be ordered with full front trim. FIA approved bolt-on side impact head rest fits both single skin and twin skin versions.



3
Reverie Super Sports twin skin bolt-on side impact head rest with FIA black spacer fabric trim.

The Super Sports weighs between 4.4 and 5.2KG depending on variant. See [page 34](#) for a full list of weights

See [page 34](#) for seat dimensions



2
Billet FIA universal or Lotus side mounts available, see from [page 39](#)

Part No.	SUPER SPORTS BUCKET SEATS	(£)
1	R01SI0106 FIA Approved 8855-1999 Super Sports B (SS) Black Fabric Trimmed	£1149.75
2	R01SI0091 FIA Approved 8855-1999 Super Sports (TS)	£1749.00
3	R01SI0101 FIA Approved 8855-1999 Super Sports (TS) FIA Fabric Trimmed	£1925.00
	R01SI0108 Super Sports (TS) FIA Fabric Trimmed (not FIA Approved)	£1395.00
	R01SI0107 Super Sports (TS) (not FIA Approved)	£1153.95
SEAT ACCESSORIES		
4	R01SI0094 Bolt-on FIA Approved Side Impact Head Restraint	£450.45

(SS) = Single Skin
(TS) = Twin Skin

SPECIFICATIONS

Dim.: [\(see page 34\)](#)
Weight: from 4.4KG
Material: Carbon Fibre
Fitment: Universal



1
Trimmed single skin



3
Trimmed twin skin



Trimmed single skin



Trimmed twin skin

2



Polished twin skin (TS) version



For our range of cushion kits, see from [page 40](#)



For our range of side mounts, see [page 39](#)

>> [CLICK TO VIEW SEAT FITTING GUIDE](#)

>> [CLICK TO VIEW SEAT SIZE GUIDE](#)

SIDE MOUNTS



Our range of side seat mounts for 288-290mm spaced fixings are designed to fit a wide range of cars allowing the fitment of Reverie seats to almost any vehicle. Our 'universal' range fits all of our seats and offers a wide range of adjustment. Items 3, 6 and 7 are satin black powder coated for superior finish.

Item 3 (made from folded 3mm S355 steel) allows fitment of the Reverie Mulsanne B/C, X C XR C and Super Sports seats to the Lotus Elise/Exige S1, S2 and S3 (up to 2019) as well as 2-Eleven and Lotus based Vauxhall VX220. The 18 slot holes allows for a range of adjustments both for both for and aft movement and seat angle. 3 x 7/16" holes allow you to bolt on the seat side lap belt depending on seat location. The low profile design allows the seat to be as low as possible to the chassis floor and the lightening cut-outs help to reduce weight.

Item 6 and 7 (made from folded 3mm S355 Steel) feature a total of 19 seat adjustment holes/slots on the sides as well as extra-wide slots on the bottom flange to allow fitment of the sub frames to the seat rail/fixing point in the car.

Items 4 & 5 are CNC machined from billet Aluminium to give ultimate strength and minimum weight and then black anodised.

Part No. SEAT SIDE MOUNTS

- 1** [R01SI6190](#) Corbeau Pro-Team 90° Aluminium Mount FIA Approved (Pair)
- 2** [R01SI6189](#) Corbeau Pro-Team Aluminium Seat Mount FIA Approved (Pair)
- 3** [R01SI6215](#) Lotus Elise/Exige S1/S2/S3 VX220 Seat Mount Satin Black (Pair)
- 4** [R01SI0115](#) S/Sports Twin Skin Billet Aluminium Seat Mount for Lotus/Vauxhall (Pair)
- 5** [R01SI0111](#) S/Sports Universal Billet Aluminium Seat Mount Pair FIA Approved (Pair)
- 6** [R01SI6002](#) Reverie Universal 'Kinked' Seat Subframe Mount Satin Black (Pair)
- 7** [R01SI6212](#) Reverie Universal 'L-Shaped' Seat Mount Satin Black (Pair)
- 8** [R01SI6056](#) Universal Alloy Monoblock Fixed Seat Subframe Side Mount (Pair)

MULSANNE B SUBFRAME CONVERSION KIT

- 9** [R01SI0083](#) LHD (Drivers) for Lotus/Vauxhall/Opel (various) £69.25
- 10** [R01SI0086](#) LHD (Passenger) for Lotus/Vauxhall/Opel (various) £122.80
- 11** [R01SI0087](#) RHD + LHD Seat Subframe Nylon Spacer Kit (Mulsanne B) £26.24
- 9** [R01SI0081](#) RHD (Drivers) for Lotus/Vauxhall/Opel (various) £69.25
- 10** [R01SI0085](#) RHD (Passenger) for Lotus/Vauxhall/Opel (various) £122.80

MULSANNE C/XC/XR C SUBFRAME CONVERSION KIT

- 11** [R01SI0053](#) LHD (Drivers) for Lotus/Vauxhall/Opel (various) £58.75
- [R01SI0064](#) LHD (Passenger) for Lotus/Vauxhall/Opel (various) £112.30
- [R01SI0039](#) RHD (Drivers) for Lotus/Vauxhall/Opel (various) £58.75
- [R01SI0063](#) RHD (Passenger) for Lotus/Vauxhall/Opel (various) £112.30

£ (Ex. VAT)

9		10	
Double shear Lotus subframe adaptor kit (LHD)		Double shear Lotus subframe adaptor kit (RHD)	
		11	
		Mulsanne B RHD/LHD spacer only kit	

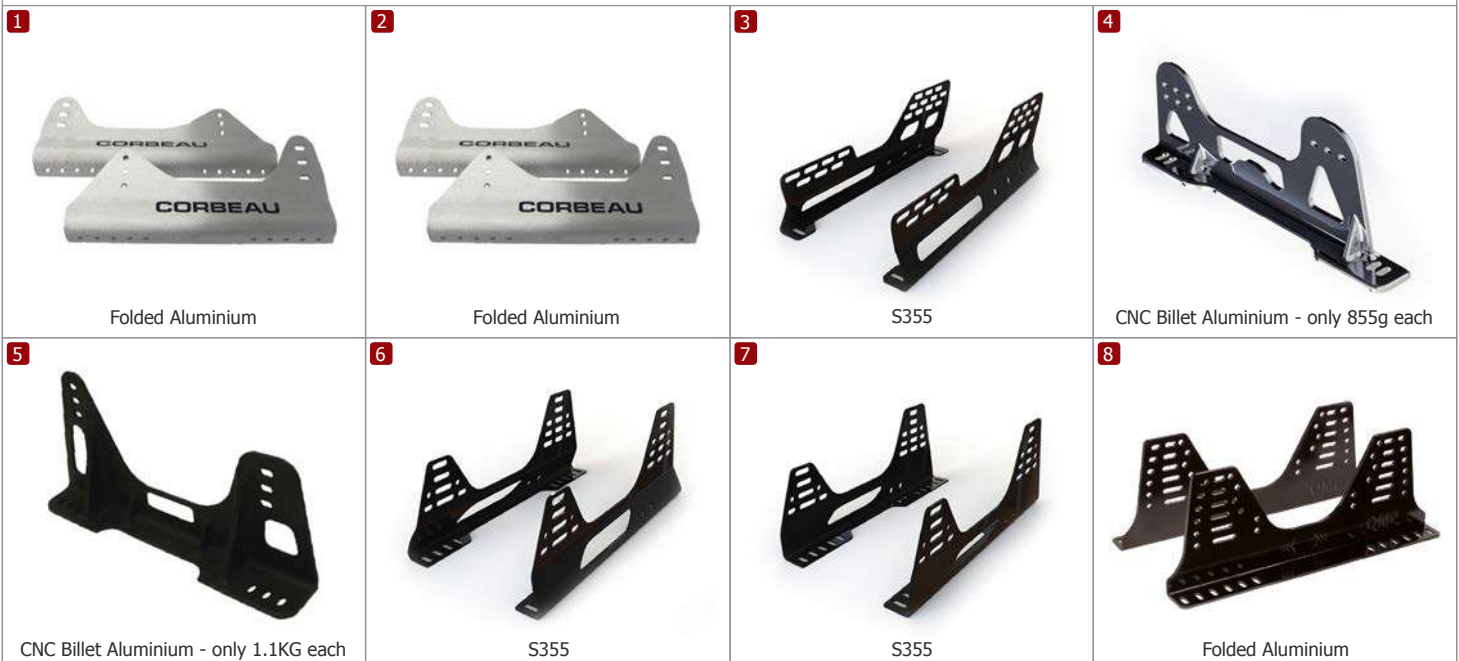

>> [CLICK TO VIEW SEAT FITTING GUIDE](#)

>> [CLICK TO VIEW SEAT SIZE GUIDE](#)

BRUSHED NYLON/ BLACK FOAM

Part No.	BRUSHED NYLON	£ (Ex. VAT)
1 R01SI6043	(N) Brushed Nylon Black	£109.67
2 R01SI6043B	(N) Brushed Nylon Blue	£109.67
3 R01SI6043DB	(N) Brushed Nylon Dark Blue	£109.67
4 R01SI6043DG	(N) Brushed Nylon Dark Grey	£109.67
5 R01SI6043R	(N) Brushed Nylon Red	£109.67
BLACK PLAIN NON-TRIMMED FOAM		
6 R01SI0007	(N) Mulsanne X & XR Black	£34.60
SUPPORT CUSHIONS		
7 R01SI6162	Brushed Nylon Seat Lumbar Support Cushion - Black, Velcro Fit	£31.49
8 R01SI6163	Brushed Nylon Seat Side Support Cushions - Pair, Velcro Fit	£35.69

(N) = Narrow Seats (Mulsanne B/C, X C, XR C, S/Sports)



R01SI6043B blue cushion kit on narrow X C

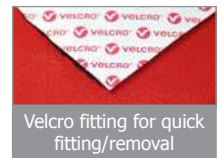

Velcro fitting for quick fitting/removal



>> [CLICK TO VIEW SEAT FITTING GUIDE](#)

>> [CLICK TO VIEW SEAT SIZE GUIDE](#)

DINAMICA

Part No.	DINAMICA	£ (Ex. VAT)
1 R01SI6045	(N) Black	£142.80
2 R01SI6194	(N) Green, B/Nylon Yellow Back & Stitching	£142.80
3 R01SI6045G	(N) Grey	£142.80
4 R01SI6045R	(N) Red	£142.80
5 R01SI6045RB	(N) Royal Blue	£142.80

(N) = Narrow Seats (Mulsanne B/C, X C, XR C, S/Sports)



R01SI6045 black cushion kit on Mulsanne B

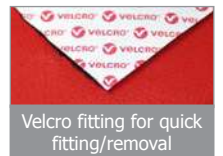

Velcro fitting for quick fitting/removal



>> [CLICK TO VIEW SEAT FITTING GUIDE](#)

>> [CLICK TO VIEW SEAT SIZE GUIDE](#)

FIA SPACER FABRIC

Part No.	FIA SPACER FABRIC	£ (Ex. VAT)
1 R01SI6135	(N) Black	£109.67
2 R01SI6208	(N) Black, B/Nylon Black Back & Stitching	£109.67
3 R01SI6204	(N) Black, B/Nylon White Back & Stitching	£109.67
4 R01SI6191	(N) Black, B/Nylon Yellow Back & Stitching	£109.67
5 R01SI6205	(N) Black, FIA Green Back & Stitching	£109.67
6 R01SI6135BE	(N) Blue	£109.67
7 R01SI6135G	(N) Grey	£109.67
8 R01SI6193	(N) Grey, B/Nylon Red Back & Stitching	£109.67
9 R01SI6192	(N) Grey, B/Nylon Blue Back & White Stitching	£109.67
10 R01SI6135R	(N) Red	£109.67

SUPPORT CUSHION

11 R01SI6164	FIA Black spacer fabric Side Head Rest Cushions XRC Wide and Narrow seats - Pair	£109.67
--------------	--	---------

(N) = Narrow Seats (Mulsanne B/C, X C, XR C, S/Sports)



R01SI6191 cushion kit on X C narrow

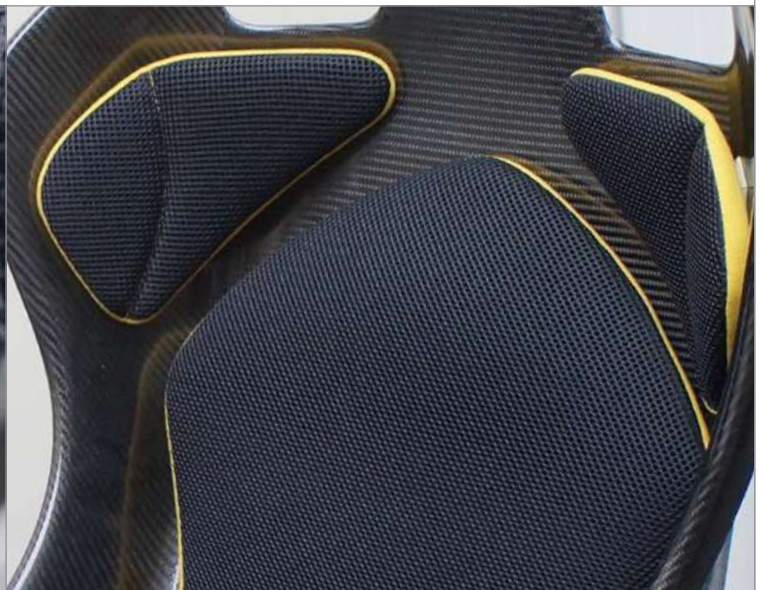
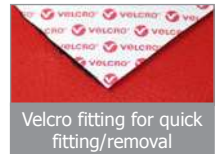
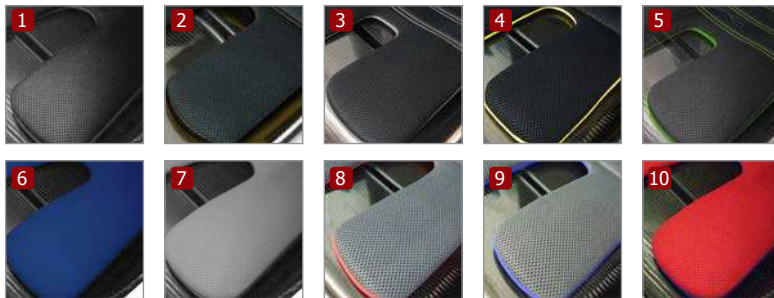

[»> CLICK TO VIEW SEAT FITTING GUIDE](#)

[»> CLICK TO VIEW SEAT SIZE GUIDE](#)

LEATHER/VINYL

Part No.	LEATHER	£ (Ex. VAT)
1 R01SI6211	(CM) Cushion Kit Carbon Black	£198.29
1 R01SI6024	(N) Carbon Embossed Black	£198.29
R01SI6078	(N) Smooth Nappa Black	£198.29
2 R01SI6007B	(N) Black	£176.14
3 R01SI6007BE	(N) Blue	£176.14
4 R01SI6007GN	(N) Green	£176.14
5 R01SI6007GY	(N) Grey	£176.14
6 R01SI6007R	(N) Red	£176.14
7 R01SI6007Y	(N) Yellow	£176.14
8	VINYL	
R01SI6009	(N) Black	£109.67
R01SI6013	(W) Black	£120.75

(N) = Narrow Seats (Mulsanne B/C, X C, XR C, S/Sports)



Velcro fitting for quick fitting/removal



Perforated leather on request

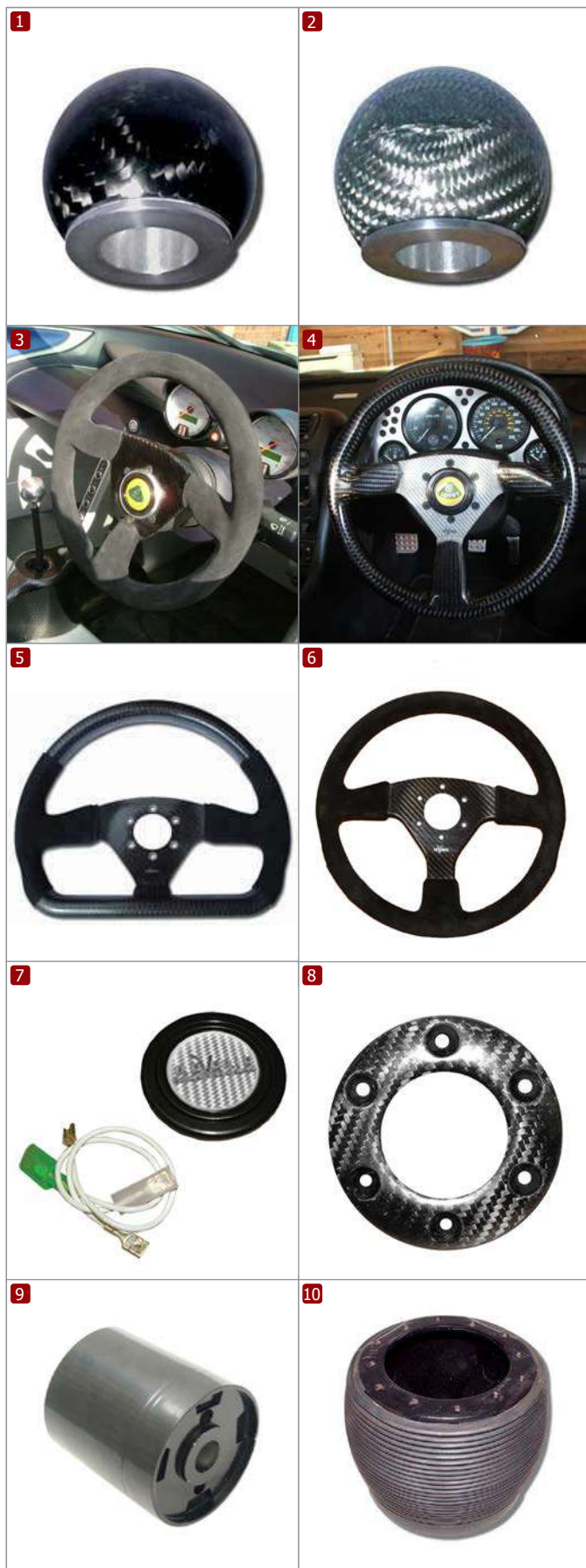

Part No.	GEAR SHIFT KNOBS CARBON LIFT-REVERSE (pre -05)	£ (Ex. VAT)
<u>R01SU0122</u>	M8-1.5 Hex Shaft Tungsten Filled, Alloy Insert	£111.77
<u>R01SU0124</u>	M8-1.5 Hex Shaft Tungsten Filled Brass Insert	£115.45
<u>R01SU0104</u>	M8-1.5 Hex Shaft Unfilled Brass Insert	£102.85
<u>R01SU0084</u>	M8-1.5 Hex Shaft Unfilled Alloy Insert	£97.60
GEAR SHIFT KNOBS CARBON LIFT-REVERSE (05 - 09)		
<u>R01SU0136</u>	M10-1.5 Round Shaft Tungsten Filled, Alloy Insert	£111.77
<u>R01SU0138</u>	M10-1.5 Round Shaft Unfilled, Alloy Insert	£102.85
<u>R01SU0144</u>	M10-1.5 Round Shaft Tungsten Filled, Brass Insert	£115.45
<u>R01SU0146</u>	M10-1.5 Round Shaft Unfilled, Brass Insert	£102.85
GEAR SHIFT KNOBS CARBON LIFT-REVERSE (09 -)		
<u>R01SU0199</u>	M12-1.5 Round Shaft Tungsten Filled, Alloy Insert	£111.77
<u>R01SU0200</u>	M12-1.5 Round Shaft Unfilled, Alloy Insert	£102.85
<u>R01SU0196</u>	M12-1.5 Post Shaft Tungsten Filled Brass Insert	£115.45
<u>R01SU0197</u>	M12-1.5 Post Shaft Unfilled Brass Insert	£102.85
GEAR SHIFT KNOBS TEXALIU M LIFT-REVERSE (pre -05)		
<u>R01SU0123</u>	M8-1.5 Hex Shaft Tungsten Filled Alloy Insert	£118.48
<u>R01SU0125</u>	M8-1.5 Hex Shaft Lift-Reverse Tungsten Filled Brass Insert	£118.48
<u>R01SU0085</u>	M8-1.5 Hex Shaft Unfilled Alloy Insert	£102.85
<u>R01SU0105</u>	M8-1.5 Hex Shaft Unfilled Brass Insert	£102.85
GEAR SHIFT KNOBS TEXALIU M LIFT-REVERSE (05 - 09)		
<u>R01SU0137</u>	M10-1.5 Round Shaft Tungsten Filled Alloy Insert	£118.48
<u>R01SU0139</u>	M10-1.5 Round Shaft Unfilled Alloy Insert	£102.85
<u>R01SU0145</u>	M10-1.5 Round Shaft Tungsten Filled Brass Insert	£118.48
<u>R01SU0147</u>	M10-1.5 Round Shaft Unfilled Brass Insert	£102.85
GEAR SHIFT KNOBS TEXALIU M LIFT-REVERSE (09 -)		
<u>R01SU0195</u>	M12-1.5 Post Shaft Tungsten Filled Brass Insert	£118.48
<u>R01SU0198</u>	M12-1.5 Post Shaft Unfilled Brass Insert	£102.85
GEAR SHIFT KNOBS CARBON NON-LIFT-REVERSE		
<u>R01SU0128</u>	M10-1.5 Tungsten Filled Brass Insert for S1/340R	£115.45
<u>R01SU0126</u>	M10-1.5 Unfilled Brass Insert for S1/340R	£102.85
GEAR SHIFT KNOBS TEXALIU M NON-LIFT-REVERSE		
<u>R01SU0129</u>	M10-1.5 Tungsten Filled Brass Insert for S1/340R	£118.48
<u>R01SU0127</u>	M10-1.5 Unfilled Brass Insert for S1/340R	£102.85
STEERING WHEELS		
<u>R01SH0118</u>	Eclipse 280 Untrimmed MOMO/Sparco/OMP	£502.95
<u>R01SH0001</u>	Eclipse 315 Untrimmed MOMO/Sparco/OMP	£523.95
<u>R01SH0008</u>	Flight 280 Untrimmed MOMO/Sparco/OMP - Silver Centre	£603.54
<u>R01SH0002</u>	Flight 315 Untrimmed MOMO/Sparco/OMP - Silver Centre	£523.95
<u>R01SH0140</u>	Rally 330 x 260 Half Alcantara Trimmed MOMO/Sparco/OMP	£555.45
<u>R01SH0037</u>	Rally 330 Alcantara Trimmed MOMO/Sparco/OMP	£565.45
STEERING WHEEL ACCESSORIES		
<u>R01SH6003</u>	Reverie Horn Push Centre Button Kit	£20.95
<u>R01SH0057</u>	Carbon Fibre Horn Push Ring for MOMO/Sparco/OMP Fitment	£114.45
<u>R01SH6000</u>	Lotus Elise/Exige/340R Steering Wheel Boss Kit - MOMO/Sparco, 86mm OD	£49.99
<u>R01SH6028</u>	Lotus Elise/Exige S2/S3 V6 Steering Wheel Boss Kit - MOMO/Sparco, Airbag	£83.99
<u>R01SH6018</u>	Lotus Elise/Exige/340R Collapsible Steering Wheel Boss Kit - MOMO/Sparco	£78.95

More information on gear shift knobs and steering wheels can be found in our Universal Parts Brochure available for download at www.reverie.ltd.uk/brochure-downloads.php



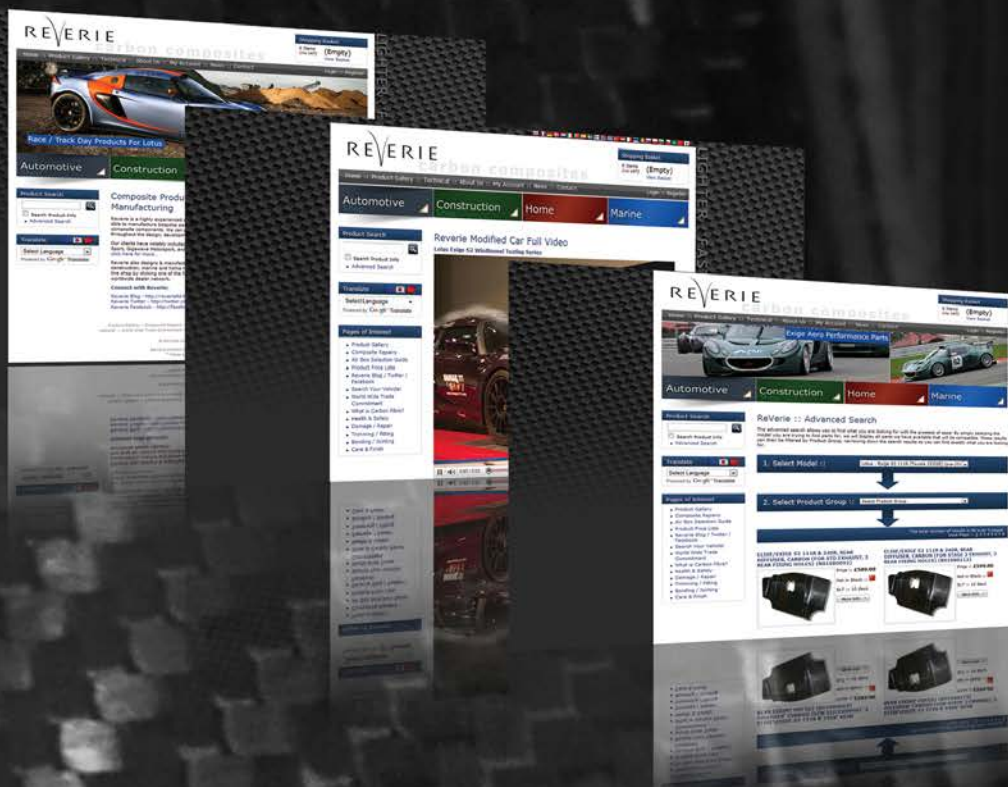

VISIT WWW.REVERIE.LTD.UK FOR WORLDWIDE DEALERS

Download latest prices, technical data, drawings and digital versions of our brochures for free.
Advanced search function available to show all parts that are compatible with your car.

AUTHORISED DEALER STAMP

Reverie Limited
Unit 2 Chandlers Row
Colchester
Essex
CO1 2HG
UK

DISCLAIMER: Reverie Limited is not associated with any of the vehicle manufacturers or brands listed in this brochure. Manufacturer logos are used for identification purposes only. Reverie Limited does not manufacture OEM parts listed herein.

WARNING! MOTORSPORT OR DRIVING CAN BE DANGEROUS RESULTING IN DEATH OR PERSONAL INJURY. READ OUR FITTING INSTRUCTIONS CAREFULLY Reverie automotive products are for "motorsports use only". We cannot be held responsible for misuse of our products. This article is sold without warranty expressed or implied. No warranty or representation is made as to this product's ability to protect the user from injury or death. The user assumes that risk. The effectiveness, warranty and longevity of this equipment are directly related to the manner in which it is INSTALLED, USED, and/or MAINTAINED. THE USER ASSUMES THE RISK. Fitment of Reverie products to automobiles that are subject to a manufacturer's warranty MAY VOID THE MANUFACTURER'S WARRANTY AND THE VEHICLES ABILITY TO MEET EMISSION OR OTHER TRANSPORT REGULATIONS. By purchasing this product and/or opening the packaging, users / purchasers expressly acknowledge, understand and agree that they take , select and purchase these REVERIE products from REVERIE, its affiliates, distributors, and agents (collectively, REVERIE) "as is" and "with all faults". The entire risk as to the quality and performance of these REVERIE parts is with the purchasers. Should the goods prove defective following their purchase; the purchasers assume the entire cost for all necessary servicing or repair or any resulting liability. Working on your car can be a dangerous activity. If you are unsure of what you are doing, please leave mechanical or Safety critical work to a skilled mechanic. We take no responsibility for the incorrect use and / or installation of REVERIE products. If this Carbon fibre product is exposed to sunlight / UV then it should be regularly UV coated with Armour-all protect ant or sanded and 2k clear lacquered. Prolonged exposure to UV will 'yellow' the epoxy and lead to slow deterioration of structural performance (more info available on our web site or on request).

Web: www.reverie.ltd.uk
 Email: sales@reverie.ltd.uk
 Tel: +44 (0)1206 866663
 Tech Sales: +44 (0)1206 913465
 Accounts: +44 (0)2081 235997
 VOIP: +44 (0)1206 868144
 Skype: +44 (0)2081 235997



Copyright © 2020 Reverie Ltd - Version: 0002

reverie_composites 
facebook.com/reverieltd
twitter.com/reverieltd
instagram.com/reverieltd

REVERIE

LIGHTER | FASTER | STRONGER